

# PASCO<sup>®</sup>

Celebrating 60 Years of Innovation

## SCIENCE & TECHNOLOGY

Biology • Chemistry • Environmental • Physics

### Featuring!

- Wireless Sensors
- STEM Solutions
- Lab Bundles
- Curriculum
- And More

## TRANSFORMING SCIENCE & STEM EDUCATION

### **NEW!**

Wireless Dissolved  
Oxygen Sensor &  
Photosynthesis  
Chamber  
(page 45)

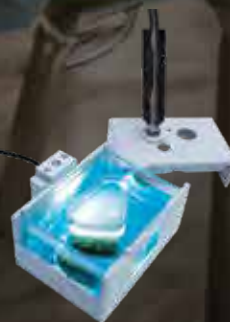

**FREE!** SPARKvue Software  
Award-Winning Software Free for All Devices  
(pages 4-5)

60 YEARS OF

INNOVATION

# PASCO is Celebrating 60 Years of Innovation in Science Education

60 years ago, PASCO scientific introduced its first product, the Millikan Oil Drop Experiment, that had its origins as a high school science project. Amazingly, schools ordered this apparatus from a company they had never heard of – displaying a great amount of trust in a new company.

And for the past 60 years, high schools and colleges have continued to place their trust in the apparatus we design, manufacture, sell and support. For that trust over the years, we simply say, **“Thank You!”** With your continued support and suggestions, we will strive to maintain that trust into the future.

What have we been doing for the past 60 years? I invite you to peruse our catalog and see the hundreds of products that bear the name PASCO.





**NEW!** Standard Compound  
Optical Microscope.  
(Page 51)



**NEW!** Melting Point Apparatus  
(Page 70)

## Table of Contents

PASCO Solution Overview .....	2
Elementary.....	8
Middle School .....	10
MindLabs.....	15
STEM/Coding .....	16
Engineering.....	30
Biology .....	36
Chemistry .....	52
Environmental.....	72
Physics.....	84
Sensors .....	114
Equipment Storage .....	126
Index.....	128
Order Form.....	134
Support & Consulting.....	136



**NEW!** Motorized Structures Systems  
(Pages 31-35)



**Sensor Technology**

Our innovative, award-winning wireless sensors are rugged, low-cost, and easy to use. Explore our growing line of more than 30 wireless sensors!



**Data Collection & Analysis Software**

Intuitive SPARKvue® works on iOS, Android™, and Chrome™ devices, as well as Mac® and Windows® computers. It even includes Blockly block-based coding, which allows students to code with any PASCO sensor.



**Complete Lab Stations**

PASCO Lab Stations make it easy to use sensor-based technology in your science classroom. Discover Lab Stations for Biology, Chemistry, Agricultural Science, Physics, Middle School Science, and K-5 Science.



**Curriculum Solutions**

The Essential curriculums are the only curricular solutions that include a Student Textbook, an e-Book, Teacher e-Resources, Lab Manuals, and award-winning equipment kits.



**STEM & Coding Solutions**

STEM Sense solutions promote early excellence in science and STEM education with cross-curricular investigations that help young learners build strong foundations in science, programming and data literacy.



**Storage & Classroom Management**

Use these rolling carts and storage trays to decrease your classroom management time and increase teaching and learning time.



# Sensor Technology

PASCO's award-winning line of wireless sensors are durably designed, easy to use, and affordably priced to help educators bring real-world technology into the hands of students everywhere. Our wireless sensors feature student-friendly designs, manual and automated data collection, interactive displays and other modern features that enhance science learning. Plus, they connect directly to computers, Chromebooks, tablets, and mobile devices, allowing students to quickly collect data, so they can spend more time analyzing and interpreting their results.

- Original PASCO innovations, such as the //code.Node, Smart Cart, Modular Circuits and Wireless Weather Sensor with GPS
- Award-winning software supports Blockly coding for every sensor
- Onboard sensor memory with Logging Mode for long-term experiments
- Hundreds of free labs available for download from our online Experiment Library
- PASCO-ensured quality and backed by our five-year warranty



### Wireless Weather Sensor with GPS

Capable of making 19 measurements and logging GPS data, this all-in-one instrument is ideal for investigating complex environmental conditions.



### Wireless Motion Sensor

This sensor measures the position, velocity, and acceleration of objects, and it even includes a 180° rotatable head for creative applications.



### Wireless Smart Cart Patent Number 10,481,173

Upgrade to the revolutionary Wireless Smart Cart and start collecting live data for position, velocity, acceleration, force, and rotation directly on your device.



### Wireless CO<sub>2</sub> Sensor

Use this sensor to explore respiration and photosynthesis, chemical reactions, and so much more with real-time CO<sub>2</sub> data on your device.



### Wireless Colorimeter and Turbidity Sensor

This dynamic sensor simultaneously measures a sample's absorbance and transmittance at six different wavelengths, and it doubles as a turbidity sensor for water quality investigations.



### Wireless Temperature Sensor

A staple of every science class, this sensor drastically simplifies temperature measurements with its small footprint, long-lasting battery, and live datalogging.

Our growing line now includes over 30 wireless sensors!



# Data Collection and Coding

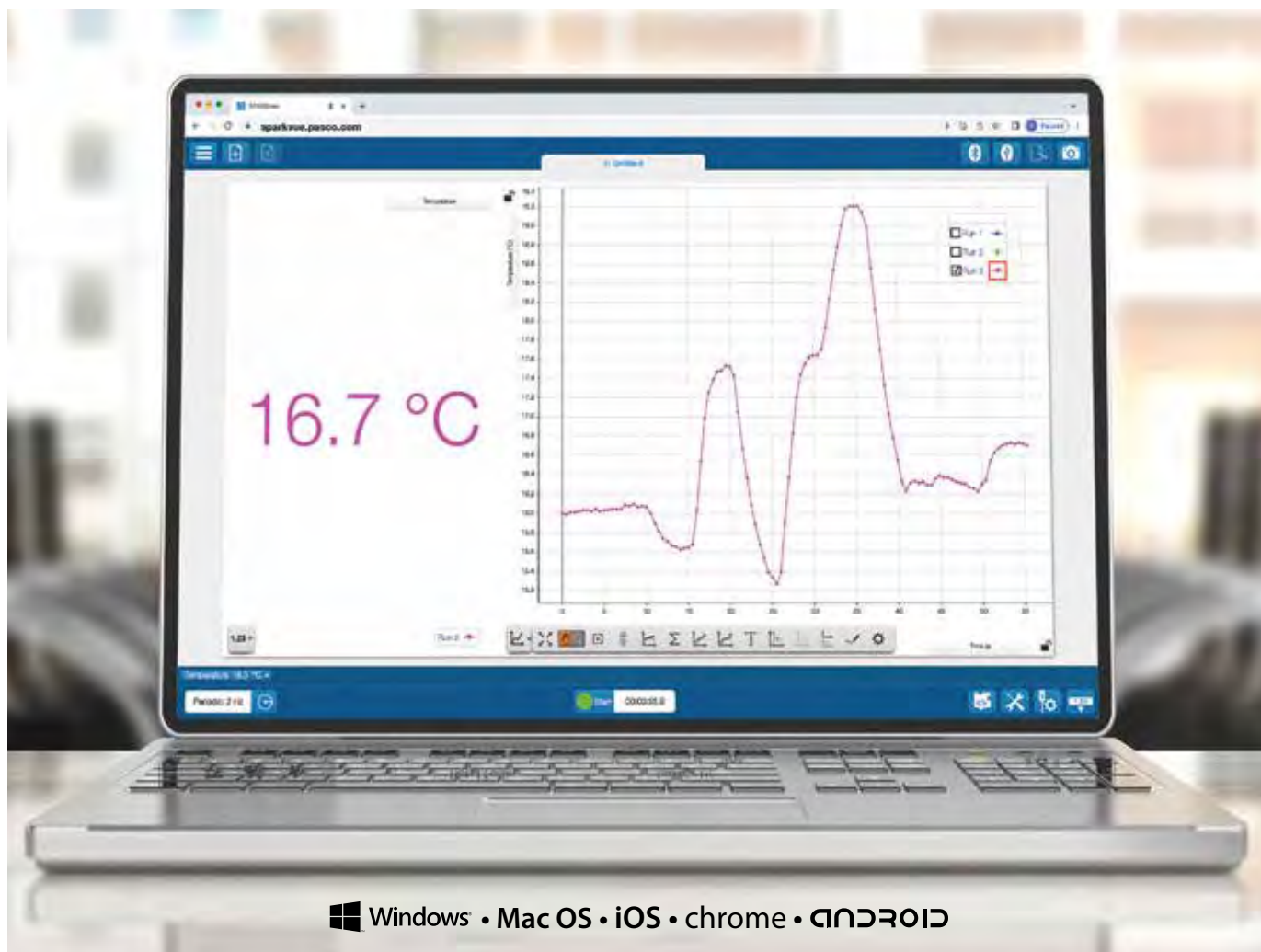

Windows • Mac OS • iOS • chrome • ANDROID



This FREE award-winning data collection and analysis software works on any platform!

SPARKvue's intuitive design has made it an award-winning tool for collecting and analyzing experimental data. The user-friendly platform optimizes data collection and provides tools for in-depth analysis within a compact, yet powerful workspace.

SPARKvue features Blockly coding, allowing students to use block-based code for sense and control of PASCO devices, including any of our sensors.

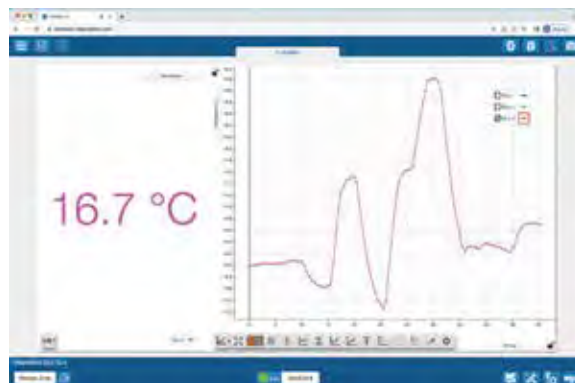

# Student Data Collection...**MADE EASY!**

## Student-Entered Data & Graphing

### MADE EASY!

Choose manual data collection to record live values with the click of a button.

Make a mistake? No problem! Simply select a data point to replace it.

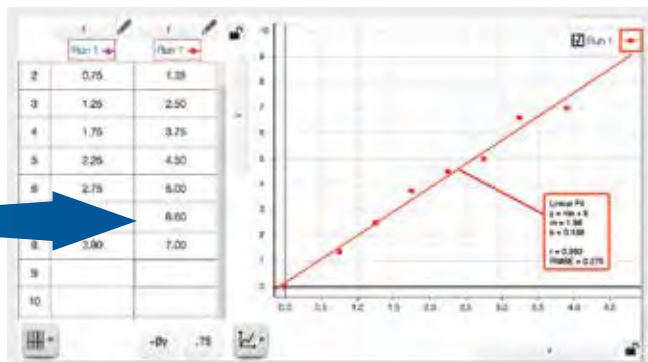
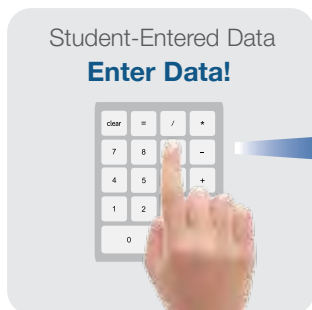

Graph & Analyze Student-Entered Data

## Collecting & Graphing Sensor Data

### MADE EASY!

Automate sensor data collection to monitor measurements in real time.

Save time with pre-made experiment files, or build your own with drag-and-drop displays that'll have you up and running in minutes.

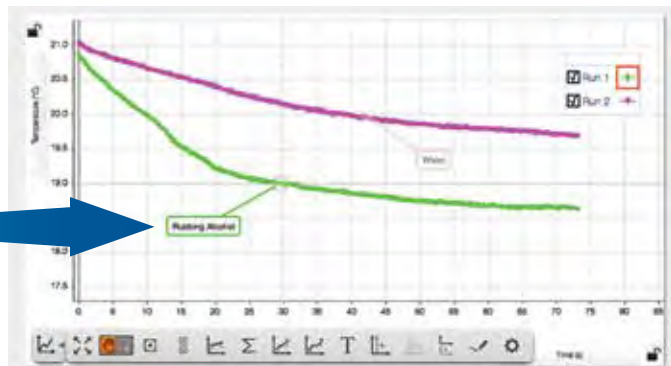
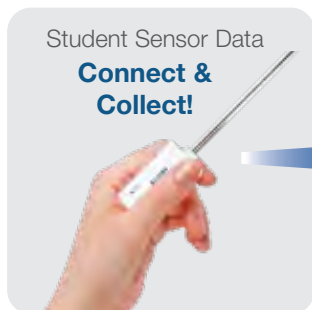

Rapid, Real-Time Data Collection & Analysis



Digits Display



Bar Graph Display



Meter Display



GIS Map Display

## Free award winning data collection and analysis software now runs in your browser!

We're excited to announce SPARKvue is now available **FREE** of charge on all your devices as a browser-based application. This new version of our software as a Progressive Web Application (PWA) means you have free access to all the features of SPARKvue from Google Chrome and Microsoft Edge browsers. That's right: No download fees, subscription fees, or update fees, even for Windows® and Mac®. Plus, the app is always updated to the latest version automatically, so you never have to worry about it.

**Go to [sparkvue.pasco.com](https://sparkvue.pasco.com) to access the PWA.** SPARKvue is also available as a **FREE** app for Chromebook™, iPad®, Android™ tablets, and Apple® and Android™ smartphones.

Launch now as a Web App **PWA** + 
 
 Download on the App Store 
 
 Available in the Chrome Web Store 
 
 ANDROID APP ON Google play

Looking for additional options? See [pasco.com/sparkvue](https://pasco.com/sparkvue) for more details.

# Science Lab Stations & Bundles

PASCO's Lab Stations make it easy and affordable to begin using sensor-based technology in your K-8, Biology, Chemistry and Environmental classrooms. Convenient Physics equipment bundles include equipment and sensor technology and are complemented by a collection of ready-made experiments.

## Elementary Science Starter Lab Station

PS-3314

Inspire a lifelong love of science, while nurturing the development of foundational STEM skills with our new Elementary Science Lab Stations (page 9).



## Middle School Science Starter Lab Station

PS-3312

Help prepare your middle school students for high school science with our ready-to-use Middle School Science Lab Stations (page 10).



## Biology Starter Lab Station

EB-6334

Make the integration of phenomena-based investigations into your Biology course seamless with our complete Biology Lab Stations. Includes sensors, labs, and more (page 37).



## Chemistry Starter Lab Station

EC-6362

Empower students to investigate chemical phenomena like never before with sensors, labs, and apparatus that make chemical concepts more meaningful (page 53).

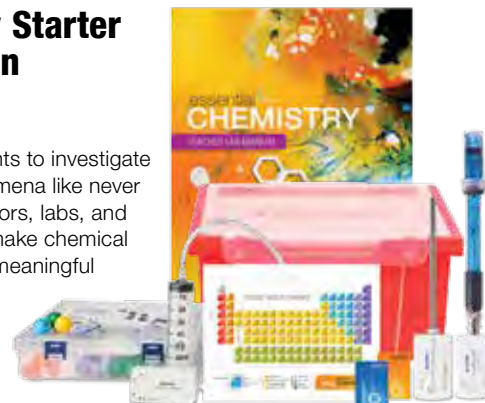

## Agricultural Science Starter Lab Station

EB-6336

Transform your classroom into an outdoor field site with our new Agricultural Science Lab Stations. Includes sensors, labs, and more (page 75).



## Physics Lab Bundles

Support hands-on physics learning all year long with our new Physics bundles, complete with sensors, labs, and more (page 86-91).





# Curriculum Solutions

## Essential Physics & Essential Chemistry

(See pages 54 and 92)

PASCO offers two complete curriculum solutions: *Essential Physics* and *Essential Chemistry*. Each program includes a Student Textbook, Student e-Book, Lab Manual, and Equipment Kits, all at a very affordable price. Other program features include:

- Animations and videos
- Flexible assessment options
- Interactive simulations
- Investigations and design challenges



# STEM Solutions

## Hands-On Coding, Sense and Control Kits

(See pages 16-29)

STEM Sense Kits engage students in the exploration of coding applications with real-world investigations into sensor technologies. Each complete kit includes hands-on, phenomena-based investigations; award-winning data collection and analysis software with block-based coding capability; our unique //code.Node device with programmable sensors, lights and sounds; and all the accessories you need to do the activities. Take student designs to the next level with the all new //control.Node and Sense and Control Kits.



# Storage & Classroom Management

## Gratnells Rolling Carts, Storage Trays and Charging Stations

(See page 126)

Gratnells storage solutions are the best way to store PASCO sensors and equipment. These movable storage rack carts include large castors with brakes for added stability, and make transporting materials to and from the classroom a breeze.

These carts can be used to store the equipment kits from the *Essential Physics* or *Essential Chemistry* curriculum, the storage trays we offer for wireless sensors, or any of the four sizes of empty trays that we offer for everything else you'd like to store.





# PASCO's Hands-On Solutions for K-8 Science

At PASCO, we develop STEM solutions so simple and accessible that even the youngest scientists can use them. Our wireless sensors and engaging activities are the perfect way to introduce K-8 students to inquiry-based discovery learning without overwhelming them. With our NGSS-based solutions, students of all ages can engage in the active learning process as they navigate their way through hands-on exercises that form lasting STEM foundations.

## K-8 Index

Elementary Stations .....	9
Middle School Stations..	10
Sensors for K-8 .....	11
Ecozones .....	16
Renewable Energy .....	16
Microscopes.....	16
MindLabs.....	17

## Elementary Science Starter Lab Station

PS-3314

The Elementary Science Starter Lab Station makes it easy and affordable to begin using sensor-based technology in your elementary science class. Inside the Starter Lab Station are the wireless sensors used to perform seven activities from the Essential Elementary Science Lab Manual. Available separately is the Elementary Science Extension Lab Station (PS-3315) which, when combined with the Elementary Science Starter Lab Station, comprises all the wireless sensors used to perform the ten labs inside the Essential Elementary Science Lab Manual. Once comfortable, you can explore our growing set of over 40 elementary labs in our online experiment library!



Elementary Science Lab Station with extension sensors



### Starter Station Lab Titles (1-7)

1. Temperature and Change
2. Evidence of Chemical Reactions
3. Thermal Insulators and Conductors
4. Can Plants Survive Without Light?
5. How a Greenhouse Works: Heat
6. How a Greenhouse Works: Light
7. MatchGraph

### Extension Station Lab Titles (8-10)

8. Determining Sound Levels
9. Weather and Climate: Microclimates
10. Weather and Climate: Monitoring Weather

The Elementary Science Starter Lab Station is a complete solution that includes these wireless sensors and materials:

- Temperature
- Light
- Motion
- Storage Case
- Lab Manual

*The Elementary Science Extension Lab Station has the additional wireless sensors (Sound PS-3227 and Weather PS-3209) needed to perform all 10 labs inside the Essential Elementary Science Lab Manual.*

### Order Information

Elementary Science Starter Lab Station .....	PS-3314
Elementary Science Extension Lab Station .....	PS-3315



## NEW! STEM GREENHOUSE KIT

Explore modern greenhouse technologies with sense and control capabilities. This solution includes all of the sensors, data collection, coding tools, and equipment you need to get started. (See pages 28-29)

## Middle School Science Starter Lab Station

PS-3312

The Middle School Science Starter Lab Station makes it easy and affordable to begin using sensor-based technology with your middle school students. Inside the Starter Lab Station are the wireless sensors used to perform six activities from the Essential Middle School Science Lab Manual. Available separately is the Middle School Science Extension Lab Station (PS-3313) which, when combined with the Middle School Science Starter Lab Station, comprises all the wireless sensors used to perform all 10 labs included inside the Essential Middle School Science Lab Manual, as well as many of the Middle School labs in PASCO's online experiment library.



### Middle School Science Lab Titles

The Middle School Science Starter Lab Station supports 6 of the 10 labs. Add the Extension Lab Station\* to do all 10 lab titles.

#### 1. Describing Motion

#### 2. Humidity and Dew Point\*

#### 3. Night and Day

#### 4. Seasons and Temperatures

#### 5. Thermoregulation

#### 6. Introduction to Acids

#### 7. Photosynthesis\*

#### 8. Acid Rain and Weathering

#### 9. Forces and Interactions\*

#### 10. Waves and Energy\*



Middle School Science Lab Station with extension sensors

The Middle/Secondary School Science Starter Lab Station includes these wireless sensors and materials:

- Temp
- Light
- pH
- Motion
- Storage Case
- Lab Manual

*The Middle School Science Extension Lab Station has the additional wireless sensors (CO<sub>2</sub> PS-3208 and Weather PS-3209) needed to perform all 10 labs inside the Essential Middle School Science Lab Manual.*

### Order Information

Middle School Science Starter Lab Station .....PS-3312

Middle School Science Extension Lab Station.....PS-3313

## Wireless Temperature Sensor

PS-3201

Welcome to the modern thermometer. Now, students can access real-time data that continuously monitors, logs, and plots temperature measurements on nearly any device. When lab time ends but the experiment continues, students can set the sensor to log data autonomously for days, then download it for analysis later. This durable, wireless sensor features a stainless steel probe for the most demanding of applications, as well as a battery that lasts up to a year. It can be used in a wide array of experiments and activities because it measures small but significant temperature changes produced by chemical reactions, convection currents, and even skin temperatures.



### Order Information

Wireless Temperature Sensor.....PS-3201  
 Wireless Temperature Sensor Pack .....PS-3330

**Note:** Price for multi-sensor packs includes 8 sensors and custom storage case.

## Wireless pH Sensor

PS-3204

The Wireless pH Sensor is a must-have for any science course. Equally capable in the lab or field, the sensor eliminates the hassle of cables, reducing spills and improving safety. Plus, it rarely requires charging; the sensor's coin cell battery lasts for 2-3 years in most labs and costs about one dollar to replace. It can transmit data in real time, or store data for days when continuous monitoring is required. The Wireless pH Sensor enhances countless activities, including acid-base titrations, investigations into household chemicals, analyses of chemical reactions, water quality studies, and much more.



### Order Information

Wireless pH Sensor.....PS-3204  
 Wireless pH Sensor Pack .....PS-3331

**Note:** Price for multi-sensor packs includes 8 sensors and custom storage case.

## Wireless CO<sub>2</sub> Sensor

PS-3208

Measure changes in carbon dioxide (CO<sub>2</sub>) gas levels quickly and easily with the Wireless CO<sub>2</sub> Sensor. This temperature-compensated sensor can operate in high humidity environments, such as the included 250-mL sample bottle, and employs live data to make core labs, such as photosynthesis, cellular respiration, and metabolism experiments engaging and impactful. With the ability to store more than 55,000 data points, the sensor also supports long-term studies of carbon cycling that span the course of a single night or an entire weekend.



### Order Information

Wireless CO<sub>2</sub> Sensor (Carbon Dioxide).....PS-3208  
 Wireless CO<sub>2</sub> Sensor Pack .....PS-3341

**Note:** Price for multi-sensor packs includes 8 sensors and custom storage case.

## Wireless Weather Sensor with GPS

PS-3209

The Wireless Weather Sensor is an all-in-one instrument for monitoring complex environmental conditions. It houses several sensing elements within a single unit to provide 19 different measurements. Use the sensor in logging mode with the Weather Vane Accessory for long-term monitoring, or use it as a handheld instrument to study microclimates and local, environmental phenomena.



### Order Information

Wireless Weather Sensor with GPS .....PS-3209  
 Weather Vane Accessory .....PS-3553

## Wireless Motion Sensor

PS-3219

The Wireless Motion Sensor connects to your device via Bluetooth® or USB, and uses ultrasound to measure the position, velocity, and acceleration of objects. This enables students to take turns measuring their own distance from the sensor, while the class observes their motion materializing as a graph in real time. The sensor can detect objects ranging from 15 cm to 4.0 m away, and with no cables to get in the way, students can explore handheld and ceiling-mounted applications.

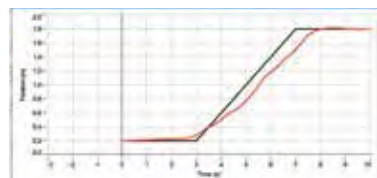
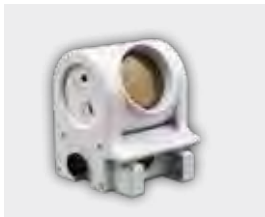

### FREE MatchGraph! Software

Download Mac®, Windows® and Android™ versions at [pasco.com](http://pasco.com). iOS version available on Apple App Store.



### Order Information

Wireless Motion Sensor .....PS-3219

Wireless Motion Sensor Pack .....PS-3337

**Note:** Price for multi-sensor packs includes 8 sensors and custom storage case.

## Wireless Force Acceleration Sensor

PS-3202

Capable of simultaneously measuring force, acceleration, and rotational velocity, this sensor is ideal for experiments involving rotating platforms, moving carts, spring oscillations, collisions, or impulse. The wireless design offers improved measurement accuracy by eliminating cords that affect data collection. Students can use the finger-holes for handheld applications, or mount it onto a cart or rod for more complex experiments.

*The Wireless Force Acceleration Sensor is perfect for explorations of Newton's 3rd Law.*

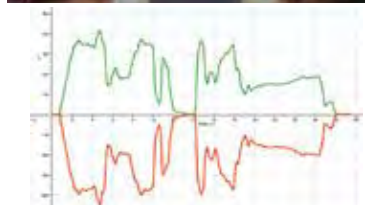

### Order Information

Wireless Force Acceleration Sensor .....PS-3202

Wireless Force Acceleration Sensor Pack .....PS-3339



## Smart Cart (Red & Blue)

ME-1240/ME-1241

The patented Smart Cart is the ultimate tool for studying kinematics, dynamics, Newton's Laws, and more. It is based on a durable ABS body with nearly frictionless wheels, just like our high quality PAScars. Now, we've added built-in sensors that measure force, position, velocity, and acceleration. The versatile Smart Cart can collect measurements on or off a track and transmit the data wirelessly over Bluetooth®. In essence, it is a wireless dynamics cart that combines all the necessary sensors, without requiring any additional hardware.

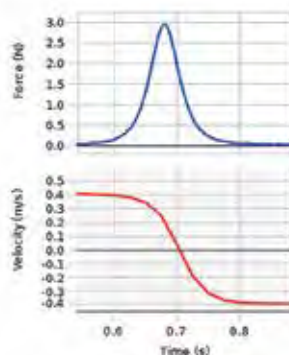

### Order Information

Smart Cart (Red) .....ME-1240

Smart Cart (Blue) .....ME-1241

## Constant Velocity Car

SE-8028A

Turn on the Constant Speed Buggy and watch it go. When it reaches a wall, it flips over and changes directions. This low-cost solution features flashing lights and a sporty appearance. Requires two "C" batteries that are not included. Actual product may vary from picture.



### Order Information

Constant Velocity Car (Constant Speed Buggy) .....SE-8028A

## Wireless Sound Sensor

PS-3227

The Wireless Sound Sensor is two sensors in one wireless package: a sound wave sensor capable of measuring changes in frequency as pitch changes, and a sound level sensor to determine and compare loudness.

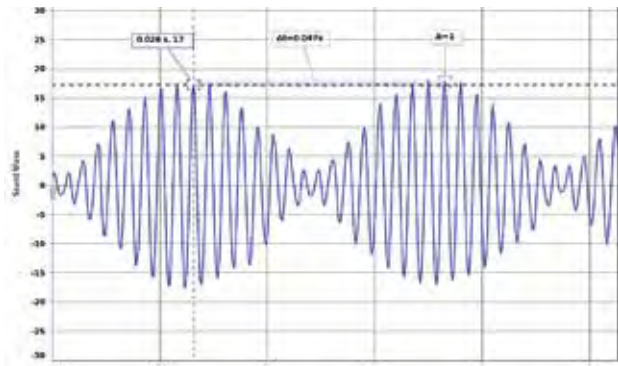

Easily observe and measure beat frequencies

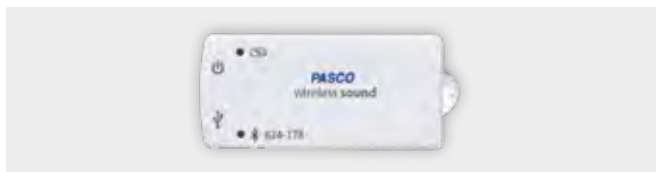

Order Information	
Wireless Sound Sensor .....	PS-3227
Wireless Sound Sensor Pack.....	PS-3342
<b>Note:</b> Price for multi-sensor packs includes 8 sensors and custom storage case.	

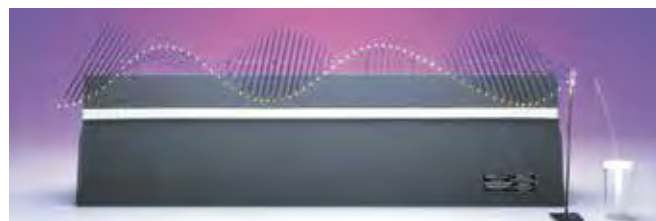

## Single Section Wave Motion Demonstrator

SE-9601

The Single Section Wave Motion Demonstrator produces mechanical waves to illustrate many of the properties and behaviors associated with different wave types. Students can explore how the velocity, frequency, and wavelength interact, visualize the superposition of waves, and easily study resonance conditions that cause standing waves.

Order Information	
Single Section Wave Motion Demonstrator .....	SE-9601

## Wireless Light and Color Sensor

PS-3248

The Wireless Light and Color Sensor features two separate apertures: One measures ambient light from the side of the box, and the other measures percent color of directional light at the end of the box.



Order Information	
Wireless Light and Color Sensor.....	PS-3248
Wireless Light Sensor Pack.....	PS-3338
<b>Note:</b> Price for multi-sensor packs includes 8 sensors and custom storage case.	

## Color Mixer

OS-8496

With three independently controllable LEDs, the Color Mixer offers a simple way to explore light and color with your students. It functions as both a demonstration tool and an expansion piece to the Basic Optics System.

The intensity of the red, green, and blue LEDs can easily be varied, either individually or all together. Demonstrating additive color mixing is as simple as using any flat surface to project the light upon.



Use it as a projector in classroom demonstrations. Individually adjust the intensity of the super bright red, green, and blue LEDs.



Order Information	
Color Mixer .....	OS-8496

## Standard Compound Optical Microscope

SE-6213

Standard optical microscope great for general viewing of cell structures at 40x, 100x, 400x viewing. Gives insights to topics from Biology, Life Science, Anatomy and Physiology, Cellular and Field Biology. High quality optical lenses allow for fine details in high contrast can be studied in appropriate detail for starter to experienced microscope users. Perfect for establishing labs with sets of durable equipment classes can use for years. Compatible with student or professionally prepared slide set like the Microscope Slide Kingdom survey (SE-6214) gives students a solid start to explore cellular features and concepts across all living kingdoms.



### Features:

- Observe small specimens like plant, animal, and bacterial cells, translucent objects such as insect larvae, or fine particles like powder
- 10 x eye piece
- 10x eyepiece and 4x, 10x, and 40x (oil) objective lenses provide magnification options of 40x, 100x, and 400x
- Adjustable focus between coarse and fine settings
- Dual light source (upper and lower LED) provides adjustable brightness
- Cord or cordless power options (External AC/DC Adaptor or 3xAA Batteries)
- Equipped with a plain stage with clip and single lens condenser with disc diaphragm

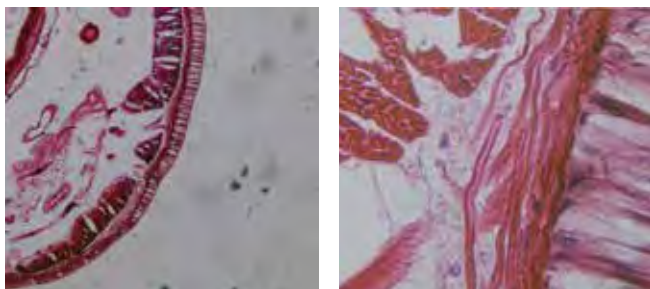

Sample imagery above captured with standard eyepiece USB camera. Slides from the *Kingdoms Survey, Prepared Slide Set* (sold separately)

### Order Information

Standard Compound Optical Microscope.....SE-6213  
 Prepared Slide Set, Kingdoms Survey .....SE-6214



## EcoZone System

ME-6668

PASCO's EcoZone System is designed to help students model and understand the complex interactions within and among different ecosystems. The three clear acrylic EcoChambers are specially designed to accommodate PASCO sensors, making qualitative and quantitative measurements very easy to observe.

With three interconnected chambers, students can model the interaction between three different ecosystems. Choose the traditional terrestrial, aquatic, and decomposition environments or create unique biomes to model and measure. Decouple the system for isolated investigations. How does the availability of light affect the ecosystem? Students can create two identical ecosystems for precise control of variable impact.

### Order Information

EcoZone System .....ME-6668



## Renewable Energy Kit

ST-7611

Using PASCO's renewable energy kit, students will be challenged to create a designs for solar and/or wind power that maximize energy output under explored sets of conditions. Students have full control of blade number, blade angles, electric loads, solar incidence, affect of dust on solar cells in order to find the optimal orientation for power generation. This is a great way to leverage the knowledge they've acquired for an engineering design challenge and bring STEM into your classroom.

### Order Information

Renewable Energy Kit .....ST-7611





## MindLabs ENERGY and CIRCUITS



Combine the fun of tabletop games with the excitement of Augmented Reality!

- Student-centered, inquiry-based learning
- Aligns with STEM standards
- Includes FREE app and circuit cards
- Each set accommodates up to 4 players
- Classroom Set accommodates up to 6 teams of 4 players

Explore energy and circuits through augmented reality with these interactive playing cards and free app. Includes six sets of twenty cards.

Gooseneck tablet stand frees up students' hands for interacting with cards and app.



**Ages 8+**

FEATURED IN



Forbes

The MindLabs Energy and Circuits Kit is a magical STEM learning tool for children ages 8 and older. It combines 20 game cards, a free digital app, and augmented reality to provide students with a fun and immersive learning experience. Play alone or collaborate with friends as you add and remove cards, draw wires, and create circuits that come to life in 3D! Students interact with characters to save the day with STEM. The ideal learning tool for solo or team play, MindLabs enables students to explore energy sources, circuits, and more.

- Create, play, and collaborate from any location!
- Assemble cards picturing batteries, light bulbs, fans, and more into working circuits
- Draw and connect wires on a mobile device to bring circuits to life
- Investigate energy resources with animated idea cards
- Step-by-step lessons guide students through basic circuit concepts
- Apply concepts to solve challenges and repair circuits

#### Features:

- Work independently or collaborate with students in any location
- Includes 20 cards and more than 20 interactive challenges with step-by-step guidance
- Extra thick cards will withstand years of use in your classroom
- Free application is intuitive and engaging for young learners
- Five full lesson plans with YouTube™ video supplements



MindLabs' app is available FREE for Apple® and Android™ tablets and smartphones.



**Minimum iOS Requirements:** iPhone SE 2016, iPad Mini Gen 5, or iPad 2017 running iOS 11 or later

**Minimum Android Requirements:** Google Pixel, Samsung S8, Moto Z2, HTC U11, or comparable devices running Android 9 or later



MindLabs Energy and Circuits kits can be purchased individually or in class sets of 6. Gooseneck Tablet Stands are included with the **Complete Class Set** only (Qty. 6).

#### Order Information

MindLabs: Energy & Circuits Single Set.....	SE-7170
MindLabs: Energy & Circuits Class Set.....	SE-7171
MindLabs: Energy & Circuits Complete Class Set .	SE-7172
Gooseneck Tablet Stand.....	SE-7173

# STEM SENSE SOLUTIONS



**STEM Sense** solutions help foster early success in science and STEM education with cross-curricular investigations that help learners build strong foundations in science, programming, and data literacy. Each complete kit includes an easy-to-use coding device, award-winning software with Blockly coding, hands-on and phenomena-based investigations, and the equipment and supplies students need to complete each activity.



Coding With Sensor  
Technologies Kit



Coding With Vehicle Sensor  
Technologies Kit



Coding With Sound & Light  
Sensor Technologies Kit



## Student Activities and Teacher Resources

Whether they're new programmers or hobby hackers, STEM Sense Kits make it easy to support students of all learning levels with a variety of scaffolded activities and open-ended challenges. Each lesson is based upon the latest science standards and incorporates cross-curricular connections to reinforce key concepts in computer science, mathematics, and language arts.

## SPARKvue + Block-Based Programming



SPARKvue offers all the benefits of a visual coding environment with additional features for data collection, visualization, and analysis. When students execute a program in SPARKvue, they can monitor sensor data collection in real time, displaying it in digits, graphs, and/or text. Students can also combine PASCO sensors and coding devices, such as the //code.Node, to create programs that interact with the physical world. With PASCO and Blockly, students can learn how to create, modify, and execute block-based coding programs while developing the skills they'll need to progress on to traditional text programming languages like Java, Python, and C++.

## Coding & Control Devices + Equipment



The //code.Node and //control.Node bridge the gap between science and computer science to provide students with hands-on learning opportunities that promote literacy in science, programming, and data collection. All PASCO coding devices integrate with our sensors and data collection and coding software, enabling students to perform basic coding with technology activities as well as more advanced sense and control investigations. STEM Sense Kits come ready-to-use with all the additional equipment and supplies required to do the activities, including magnets, tuning forks, the //code.Node Cart, the PASCObot, and much more.



PASCObot Sense &  
Control Kit



Greenhouse Sense &  
Control Kit



//control.Node Sense &  
Control Kit

## SPARKvue & Blockly Coding: Computational Thinking Meets Data Literacy

The Integration of Blockly into SPARKvue software provides science and STEM teachers with an intuitive coding platform that fits their needs. Rather than introducing students to coding independently, Blockly integrates computational thinking into the exploration of phenomena to provide learners with a new world of STEM opportunity.

With Blockly, students can create custom data collection parameters, feedback loops, data displays, and so much more.

### Use Blockly in SPARKvue to:

- Introduce students to computational thinking
- Investigate phenomena while learning to code
- Create data-driven feedback loops
- Program data collection parameters for any PASCO sensor or interface



Create code that collects, displays, and responds to sensor data! Interact with the physical world using the PASCO `//code.Node` or `//control.Node`.

Support computational thinking in science with ready-to-use Blockly extension activities.

### Free award winning data collection and analysis software now runs in your browser!

We're excited to announce SPARKvue is now available **FREE** of charge on all your devices as a browser-based application. This new version of our software as a Progressive Web Application (PWA) means you have free access to all the features of SPARKvue from Google Chrome and Microsoft Edge browsers.

Go to [sparkvue.pasco.com](https://sparkvue.pasco.com) to access the PWA. SPARKvue is also available as a **FREE** app for Chromebook™, iPad®, Android™ tablets, and Apple® and Android™ smartphones.

**SPARKvue**®

Launch now as  
a Web App

**PWA** +

Download on the  
**App Store**



Available in the  
Chrome Web Store

ANDROID APP ON  
**Google play**

Looking for additional options? See [pasco.com/sparkvue](https://pasco.com/sparkvue) for more details.

# PASCO's award-winning data collection and analysis software includes Blockly coding with data displays!

Getting started with //code.Node is quick and easy. Simply connect the //code.Node to SPARKvue and begin coding instructions for its sensor inputs and device outputs. As the code is executed, SPARKvue displays real-time data from the //code.Node's active sensors, which triggers a response from the //code.Node's lights and sounds. Other PASCO sensors may also be used in Blockly programs, enabling students to explore a new world of opportunity.



Explore more advanced coding applications with the //control.Node.

## CODING IN SPARKVUE

Use Blockly with any PASCO Wireless Sensor!

### INPUT



Select one or more //code.Node sensor inputs and a device output.

Pair //code.Node to your device, or use it in standalone mode.



Drag and drop coding blocks to create a functioning program. Then execute it!

### OUTPUT



Sensor data triggers a response in the device's sound & light outputs.

### OUTPUT

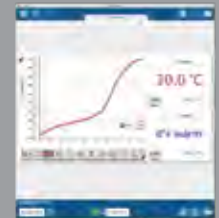

SPARKvue displays data collected by the sensor input in real time.

# HELLO

## Meet //code.Node!

The //code.Node is a hands-on coding device with interactive sensors, lights, and sounds that make learning to code a real-life STEM adventure. Designed for ages eight to fourteen, the //code.Node helps kids harness their natural curiosity to create block-based programs that bring their ideas to life.

Whether they're interested in cars, robots, sports, or science, //code.Node allows students to explore the things they love through coding. Together, the //code.Node, interactive activities, and step-by-step video lessons enable new coders to master the basics at their own pace while the accessories and wrist-strap ensure confident coders never run out of possibilities.

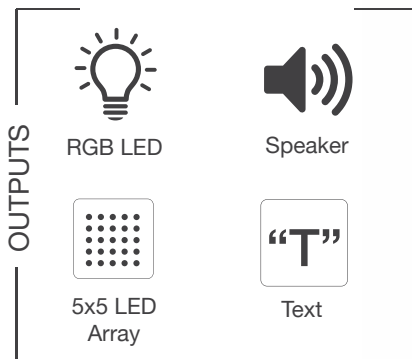
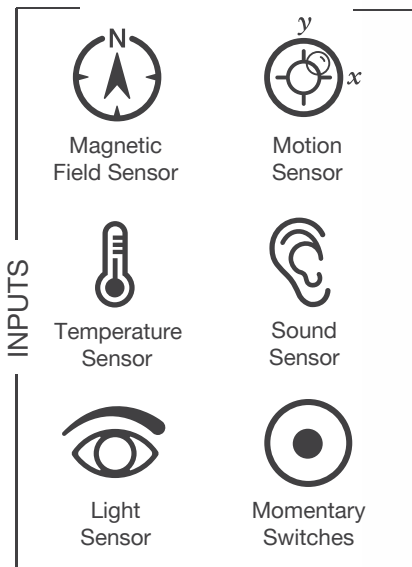

### Order Information

//code.Node .....PS-3231

//code.Node Holder.....PS-3233

//code.Node (Set of 8) .....PS-3311



## Coding with Sensor Technologies Kit

ST-7800

The Coding with Sensor Technologies Kit introduces students to coding and includes ten hands-on investigations that explore science phenomena using the //code.Node's programmable sensors, lights, and sounds.

### Student Activities and Video Lessons

The Coding with Sensor Technologies Kit includes ten investigations with video lessons, printed student worksheets, and an interactive digital flipbook that presents the resources in an engaging, student-friendly format. Each lesson is based upon the latest science standards and incorporates cross-curricular connections to reinforce key concepts in computer science, mathematics, and language arts.



### Activities and Video Lessons

- Magnetic Polarity
- Random Number Cube
- Automatic Nightlight
- Light Bulb Efficiency
- Clap On
- What's the Origin?
- Investigating Sound Levels
- Step Counter
- Intruder Alarm
- Digital Thermometer

### Build career awareness with activities that make real-world connections to:

- Engineering with real-life sensors
- Designing "smart" home technology
- Programming and developing sensor-based safety features

### Help students develop competency in:

- Problem-solving, logical reasoning, and critical thinking
- Computational thinking
- Data collection and analysis
- Mathematics
- Technology and programming



### Block-Based Coding

Blockly simplifies the programming process for new coders. Visual coding blocks connect like puzzle pieces to help students master the basics of programming without having to worry about their syntax.

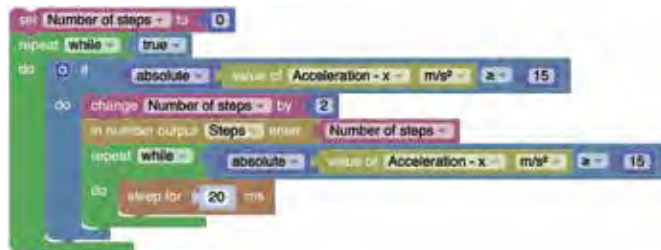

### Coding with Sensor Technologies Equipment

The Coding with Sensor Technologies Kit includes a //code.Node, two painted bar magnets, and a //code.Node Holder with wrist-strap. Wireless and easy-to-use, the //code.Node includes six sensor inputs, a speaker, RGB light, and an LED Array, all of which enable students to explore exciting phenomena using block-based programs that collect, display, and respond to data.



### Includes:

- //code.Node PS-3231
- //code.Node Holder PS-3233
- Painted Bar Magnet (Pair) SE-7593
- Color-Printed Booklet of Student Activities

### Order Information

Coding with Sensor Technologies Kit.....	ST-7800
Coding with Sensor Technologies Kit (without //code.Node) .....	ST-7801



## Coding with Vehicle Sensor Technologies Kit

ST-7820

Explore the science and sensors behind today's modern vehicles while teaching students about physical science as they design, test, measure and code with sensors that mimic real-world vehicle technology.

### Student Activities and Video Lessons

This complete kit includes five investigations with video lessons, printed student worksheets, and an interactive, browser-based flipbook that presents the resources in an engaging, student-friendly format. Each lesson is based upon the latest science standards and incorporates cross-curricular connections to reinforce key concepts in computer science, mathematics, and language arts.



### Activities and Video Lessons

- Crash Test - Impact Alert System
- Investigating Odometers
- Engineering Turn Signals
- 3-2-1 Launch!
- The Need for Speed - Radar Detectors



### Build career awareness with activities that make real-world connections to:

- Automotive engineering
- Real-life vehicle sensors
- Crash test engineering

### Help students develop competency in:

- Problem-solving, logic, and critical thinking
- Computational thinking
- Data collection and analysis
- Mathematics
- Technology and programming



### Block-Based Coding

Blockly simplifies the programming process for new coders. Visual coding blocks connect like puzzle pieces to help students master the basics of programming without having to worry about their syntax.



### Coding with Vehicle Sensor Technologies Equipment

The Coding with Vehicle Sensor Technologies Kit comes classroom-ready with all the equipment, accessories, and software needed to complete the included activities. The complete kit includes a //code.Node, a //code.Node Cart, a color-printed booklet of student activities, two light spring bumpers, six 50-g masses; a 1.5-m roll of measuring tape, a spool of thread, and two block person figurines.



### Includes:

- //code.Node PS-3231
- //code.Node Cart PS-3235
- Color-Printed Booklet of Student Activities
- Light Spring Bumpers (Qty. 2)
- 50 g Masses (Qty. 6)
- Soft Measuring Tape, 1.5 m
- Spool of Thread
- Block Person Figurines (Qty. 2)

### Order Information

Coding with Vehicle Sensor Technologies Kit .....ST-7820  
 Coding with Vehicle Sensor Technologies Kit  
 (without //code.Node) .....ST-7821





## Coding with Sound and Light Sensor Technologies Kit

ST-7830

The Coding with Sound and Light Sensor Technologies Kit engages students in the exploration of light and sound with five hands-on coding investigations that use familiar phenomena and real-world sensors to bring concepts to life.

### Student Activities and Video Lessons

This complete kit includes five investigations with video lessons, printed student worksheets, and an interactive, browser-based flipbook that presents the resources in an engaging, student-friendly format. Each lesson is based upon the latest science standards and incorporates cross-curricular connections to reinforce key concepts in computer science, mathematics, and language arts.



### Activities and Video Lessons

- What is a Color Sensor?
- RGB LED - How to Program Color
- Engineering Sound Level Meters
- Detect an Intruder - Home Alarm Systems
- Investigating Electronic Tuners



### Build career awareness with activities that make real-world connections to:

- Audio engineering and light technicians
- Programming and developing sensor-based security features
- Real-world innovations in sound and light technology

### Help students develop competency in:

- Problem-solving, logic, and critical thinking
- Computational thinking
- Data collection and analysis
- Mathematics
- Technology and programming

### Block-Based Coding

Blockly simplifies the programming process for new coders. Visual coding blocks connect like puzzle pieces to help students master the basics of programming without having to worry about their syntax.

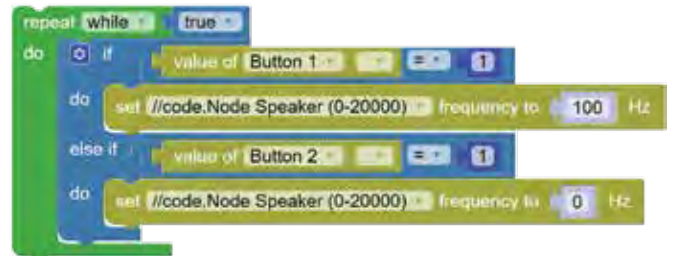

### Coding with Sound and Light Sensor Technologies Equipment

The Coding with Sound and Light Sensor Technologies Kit includes everything students need to explore concepts in light and sound through STEM. The complete kit includes: a //code.Node; a //code.Node Holder with wrist-strap; two tuning forks of different frequencies; a small flashlight; a color-printed booklet of student activities; a set of colored paper; and five sheets of aluminum foil.



### Includes:

- //code.Node PS-3231
- //code.Node Holder PS-3233
- Color-Printed Booklet of Student Activities
- Small Flashlight
- Tuning Fork, Various Frequency (Qty. 2)
- Colored Paper, Various 4"x 4" Sheets (Qty. 35)
- Aluminum Foil Sheet, 4"x 4" Sheets (Qty. 5)

### Order Information

Coding with Sound and Light Sensor Technologies Kit .... ST-7830  
 Coding with Sound and Light Sensor Technologies Kit  
 (without //code.Node) ..... ST-7831

# PASCObot

## SENSE & CONTROL KIT

When nestled inside the PASCObot, the //control.Node serves as a brain, providing both power to the bot and memory storage for students' code.



Build your bot in minutes with simple components and connector pieces that bring power to its wheels.

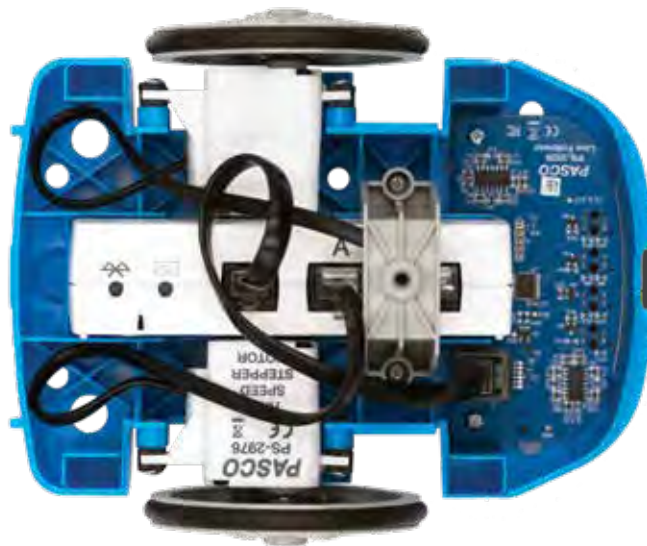

Navigate custom paths, obstacles, and more with code blocks that drive the bot forwards, backwards, or around corners and curves.



Create programs that control how the PASCObot identifies and responds to objects! Pick up a can, stack cups, or avoid objects entirely with the included Range Finder.

Stream code to the bot in real time or use the rechargeable //control.Node to run programs autonomously!

Designed for ages 11+, the PASCObot Sense & Control Kit includes everything students need to explore STEM through coding and robotics. Whether they're new programmers or hobby hackers, the PASCObot makes it easy to support students of all levels with a variety of scaffolded and open-ended activities.

This complete kit includes a PASCObot and //control. Node, as well as all the accessories needed to program how the bot interacts with its environment. From simple movements and spins to object avoidance to complex obstacle courses, there's no limit to what students can create with PASCObot.

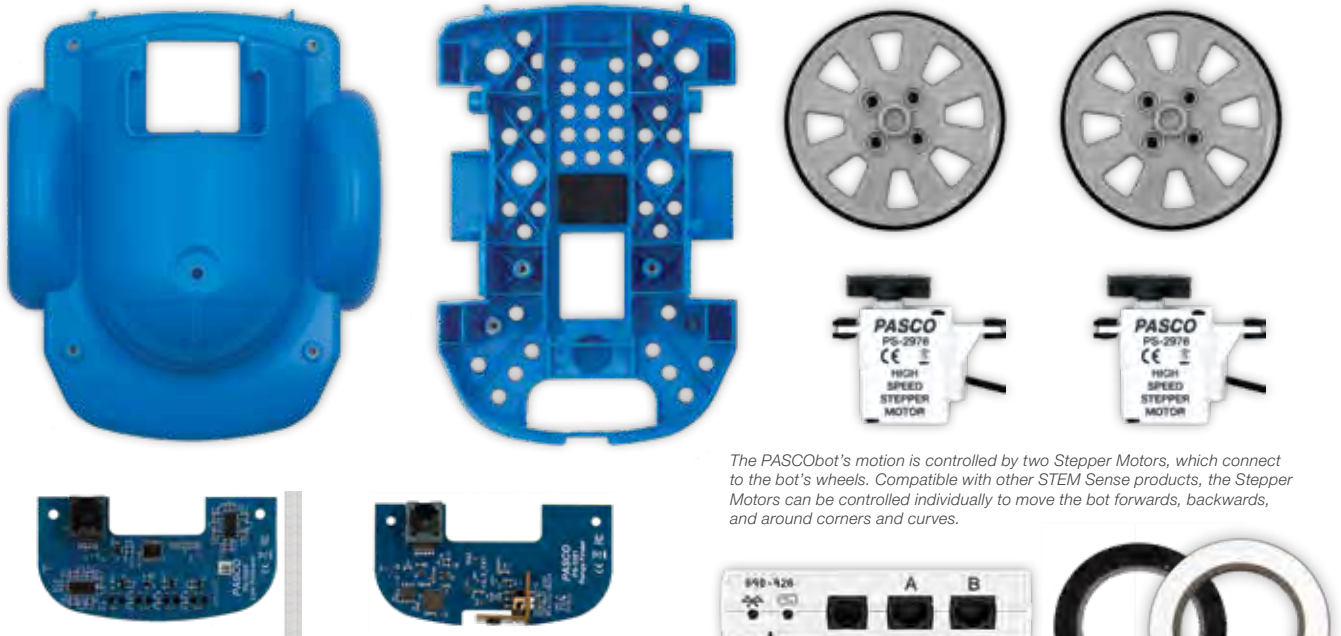

The Line Follower Module lets the PASCObot detect and respond to custom line paths that students create using the included tape.

The Range Finder Module gives the PASCObot sight, allowing it to locate, avoid, and respond to objects based on code.

The PASCObot's motion is controlled by two Stepper Motors, which connect to the bot's wheels. Compatible with other STEM Sense products, the Stepper Motors can be controlled individually to move the bot forwards, backwards, and around corners and curves.

Wireless and rechargeable, the //control. Node has two ports for stepper motors, two ports for servo motors, and one port for digital sensors.

Design custom obstacle courses using the included cups and tape. Then create code to navigate the bot through the course!

The PASCObot Gripper Accessory opens a new world of opportunity by enabling students to program the bot to move, pick up, or even stack a variety of objects. When used with the included Range Finder, the PASCObot Gripper Accessory allows students to control how the bot identifies and interacts with objects.

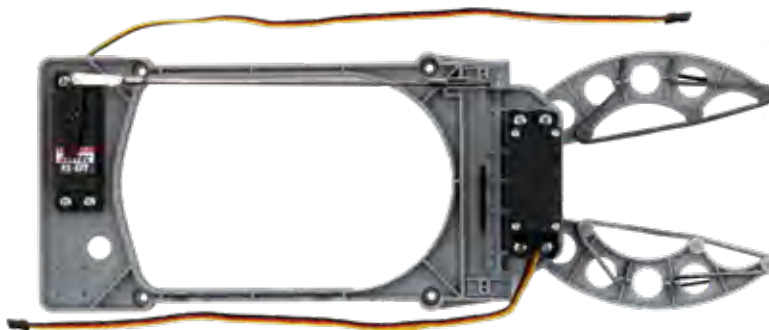

## Order Information

- PASCObot .....PS-2994
- PASCObot Sense & Control Kit .....ST-7840
- The PASCObot Sense & Control Kit (shown above) comes with the PASCObot (body, wheels, stepper motors and //control.Node) and all of the modules and accessories shown above. See below and right for individual ordering.*
- PASCObot Line Follower Module .....PS-3320

## Order Information

- PASCObot Range Finder Module.....PS-3321
- PASCObot Gripper Accessory .....PS-3325
- PASCObot Servo Motor .....SE-2975
- Black and White Tape (rolls) .....SE-2953
- Colored Plastic Cup Set (5).....SE-2952



## Greenhouse Sense & Control Kit

ST-2997

Designed for the exploration of biological and ecological concepts, the Greenhouse Sense & Control Kit includes everything students need to design, build, program, and study their very own greenhouse.

### Student Activities

The Greenhouse Sense & Control Kit includes five student activities that can be edited to fit your course needs. Each activity focuses on a key concept in biology or environmental science and includes extensions to engineering and design practices.



### Student Activities

- Program a Sunny Day for Plants
- Code a Cooling Breeze
- Program Perfectly Timed Rain
- Optimize Water Movement
- Program a Greenhouse Sense and Control System

### Build career awareness with activities that make real-world connections to:

- Agricultural monitoring
- Ecological management
- Plant physiology

### Help students develop competency in:

- Coding
- Problem solving
- Data collection and analysis
- Ecological concepts
- Science and Engineering practices



### Block-Based Coding

The Blockly integration within SPARKvue software makes it easy for students to master the basics of programming, without having to worry about their syntax. Rather than overwhelming students with options, Blockly focuses on building coding literacy through a library of customizable, drag-and-drop coding blocks.

As they combine coding blocks, students are provided with visual feedback that lets them know whether two coding blocks are compatible. After mastering the basics, students can go on to create their own programs, complete with custom conditions, commands, data displays, and more. With Blockly and STEM Sense, students can pursue all types of investigations—from single-day experiments to semester-long studies.

### Greenhouse Sense & Control Kit Equipment

This complete kit includes an EcoChamber and //control.Node, Soil Moisture Probe, Power Output Module, USB Fan, and Water Pump, PASCO Grow Light, tubing with drip-watering ends, and a Greenhouse Sensor that measures light, temperature, humidity, and soil moisture.



### Order Information

Greenhouse Sense and Control Kit.....ST-2997

Create your own ecosystem, optimize growth, and more!

Support authentic science practices while conserving time with automated sensor measurements that make daily observations quick and easy.

Use data from the Soil Moisture Probe to optimize watering schedules for specific species and microhabitats.

Plug your own devices into the included Power Output Module to extend your investigations.

Make data-based decisions with measurements for humidity, temperature, light, and soil moisture.

Ideal for studies in biology, environmental science, and STEM, the Greenhouse Sense & Control Kit comes fully customizable, enabling students to explore countless interactions between plants and environmental factors.

Program the PASCO Grow Light to automate light cycles, alter the LED color, or compare the effects of different lighting conditions.

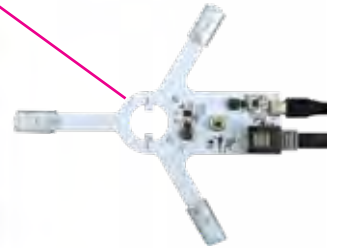

Investigate the effects of temperature, humidity, and wind disturbance.

Design a water source, complete with pump, and control it using code!



The //control.Node serves as the Greenhouse's brain, providing power to the light, fan, water pump, and sensors!

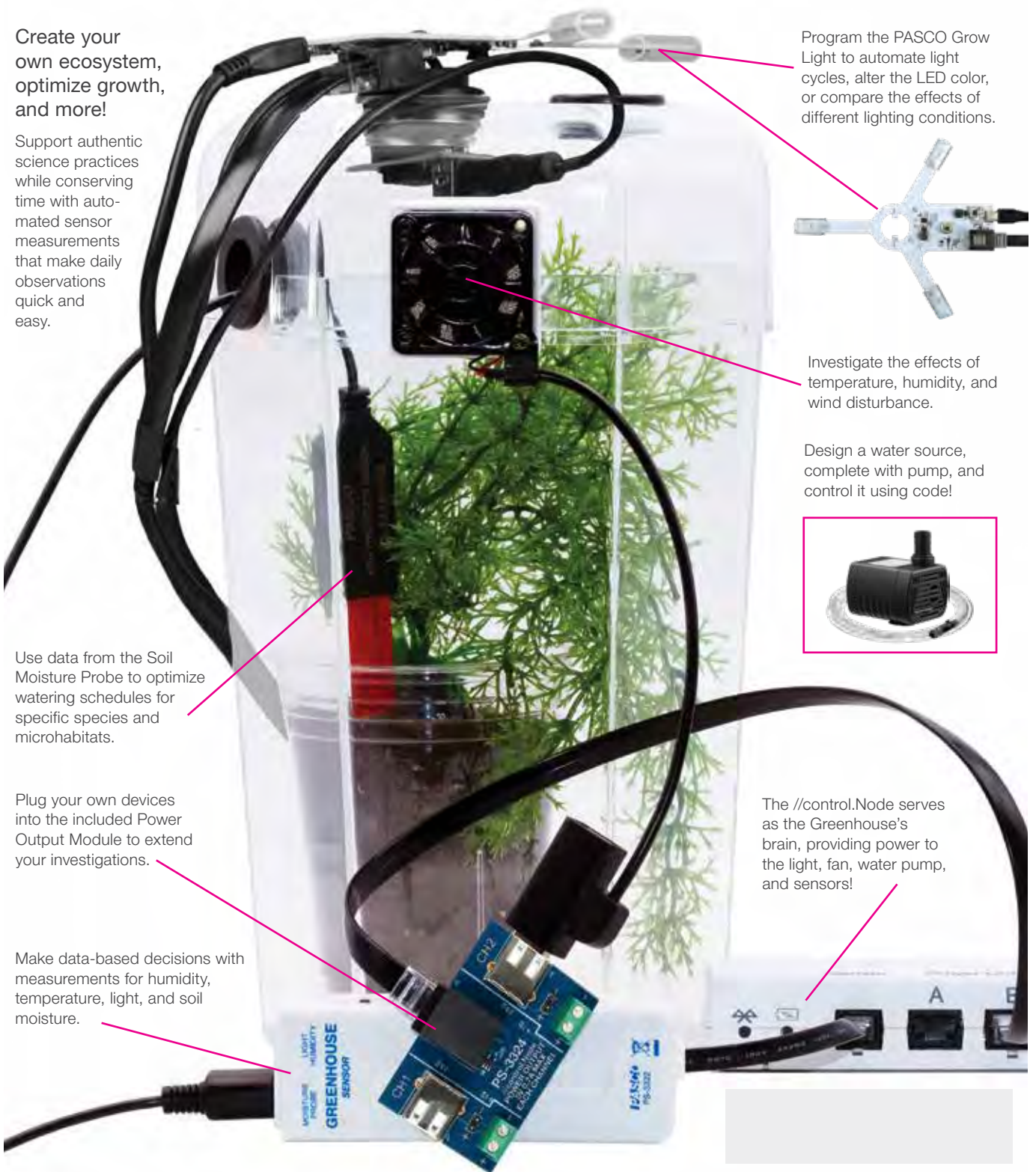

Potential topics of study include soil moisture, humidity, temperature fluctuations, light availability, inter- and intraspecies competition, wind disturbance, and so much more.

# //control.Node

## SENSE & CONTROL KIT

The //control.Node Sense & Control Kit helps students discover the engineering and design process through a series of exploratory STEM challenges. It includes a wide variety of programmable components—ranging from smart coding devices and accessories to servo motors and supplies. A collection of six scaffolded, starter projects is also included to help students practice applying elements of the engineering and design process to various real-world scenarios.



### //control.Node Sense & Control Kit

PS-5050

The //control.Node Sense and Control Kit empowers students to create and explore through code. This kit includes a //control.Node and accessories that students can use to turn on lights, run a cooling fan, open doors, launch rubber bands, and much more. The kit also includes materials and instructions for six projects:

- Night Light
- Game with Meter
- Automatic Door Opener
- Thermostat-Controlled Fan
- Light-Activated Winch
- Remote Control Rubber Band Launcher

#### These projects use elements of the engineering design process:

- Define the problem
- Research solutions
- Design a prototype
- Test solution
- Iterative design and improvement



#### GET STARTED

Learn about the components of PASCO's //control.Node Sense & Control Kit (PS-5050) and how to program them with Blockly code, included with SPARKvue software.

## //control.Node Sense & Control Kit



Motor Bracket and Stand



USB Fan  
PS-6206



Power Output Module  
PS-3324



//control.Node PS-3232  
(ships in separate box)



Servo Motor  
SE-2975

//code.Node  
PS-3231



Lightbulb & Stand  
with Cable



Pulley



Stepper Motor  
PS-2976



Small Magnet



Jumbo Paper Clips  
Qty. 10



Rubber Bands  
Qty. 10

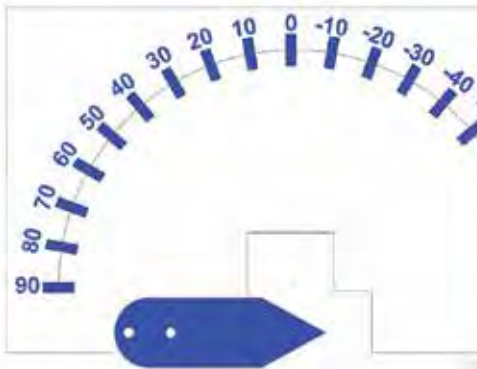

House and Meter Paper Templates

Note: Not pictured are 4 bolts and 4 nuts.



### Includes:

- //control.Node
- //code.Node
- Servo Motor
- High Speed Stepper Motor
- Fan (USB)
- Lightbulb and Stand
- Motor Bracket and Stand
- Power Output Module
- Physics String (not pictured)
- Small Magnet
- Pulley
- Electrical Wires (2)
- Rubber Bands (10)
- Paper Clips for Servo Pushrods (10)
- Mounting Bolts and Nuts for Motors
- House and Meter Paper Templates
- Phillips Screwdriver (not pictured)

### Order Information

//control.Node Sense and Control Kit..... PS-5050

Sense and Control Kit (without //control.Node) .....PS-5051

*This kit is intended for courses that already have a //control.Node. The kit is identical to PS-5050 except it does not include a //control.Node (PS-3232).*

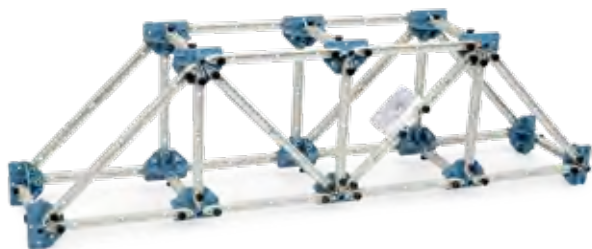

## Building Better Bridges Kit

ME-3581

Now is the perfect time for your students to learn about bridge-building and how bridges really work. This complete STEM kit allows students to learn and apply engineering design concepts. They can use the included I-Beams to build bridges and structures that behave like the real thing! And, with the included Wireless Load Cell, students can measure forces under tension or compression anywhere in their structures.

### Concepts:

- Forces in Equilibrium
- Internal Forces
- Moments in Equilibrium
- Strength of Members
- Truss Analysis

### Includes:

- Lab Activities (Qty. 1)
- Wireless Load Cell and Accelerometer (Qty. 1)
- Truss Connector (Qty. 16)
- Truss Screw (Qty. 80)
- Sliding Connector (Qty. 1)
- Mass Hanger (Qty. 1)
- Weight Set (Qty. 1)
- #1 Flexible I-Beam Member (Qty. 6)
- #2 Flexible I-Beam Member (Qty. 2)
- #3 Flexible I-Beam Member (Qty. 10)
- #4 Flexible I-Beam Member (Qty. 18)
- #5 Flexible I-Beam Member (Qty. 8)
- Gratnells® Storage Tray and Foam Liner (Qty. 1)

Building Better Bridges includes everything students need to build, measure, and test a truss bridge—plus a Gratnells® Storage Tray to keep it all organized.



### Order Information

Building Better Bridges Kit .....ME-3581



With the PASCO Structures System, students can quickly build, test, and redesign their structures while learning about the engineering process. Construction is easy: Simply fit an I-beam into a Connector, and secure it with thumbscrews.



Wireless Load Cells can be placed anywhere in your structure to make real-time measurements of tension and compression.

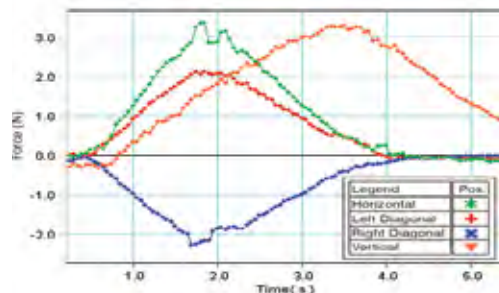

PASCO software lets students create live graphs of forces over time, compare measurements from different points, and analyze their results.



## Motorized Crane

**NEW**

ME-7030

The Motorized Crane is made using PASCO Structures and is controlled and powered by the //control.Node. Students program the controller to run the stepper motor and servo motors using Blockly coding embedded in PASCO Capstone or SPARKvue software.

The crane picks up objects with an electromagnet which is also controlled and powered by the //control.Node. Students can vary the duty cycle to vary the power of the electromagnet to explore the minimum power required to pick up different objects.

Steel washers are included with stickers to non-ferrous objects such as paper cups so the electromagnet can pick up a variety of objects.

The crane includes three sets of gears to explore the effect of gear ratios (1:1, 2:1, 4:1) on speed and lifting capability.

### Activities:

- Build the Motorized Crane
- Introduction to Stepper and Servo Motors
- Position Boom Angle and Electromagnet height to reach a position
- Pick up a ball and drop it into a cup on a different level
- Effect of Gear Ratios on Speed
- Effect of Duty Cycle on the Load the Electromagnet Can Lift
- Effect of Spool Diameter

### Features:

- The controller can execute its code via Bluetooth® or USB connection to a computer or autonomously via uploaded code.
- The motors and electromagnet on the crane are powered by the rechargeable battery in the //control.Node.
- The position and speed of the stepper motor and electromagnet can be displayed in the software while the code is executed.
- The cable spool has two diameters to learn about mechanical advantage.
- The //code.Node accelerometer is used as a joystick to move the crane so the crane can learn the locations of certain positions.
- Students build the crane and can change the design using additional Structures parts.
- Any PASCO sensor can be used with the crane to expand its capabilities.

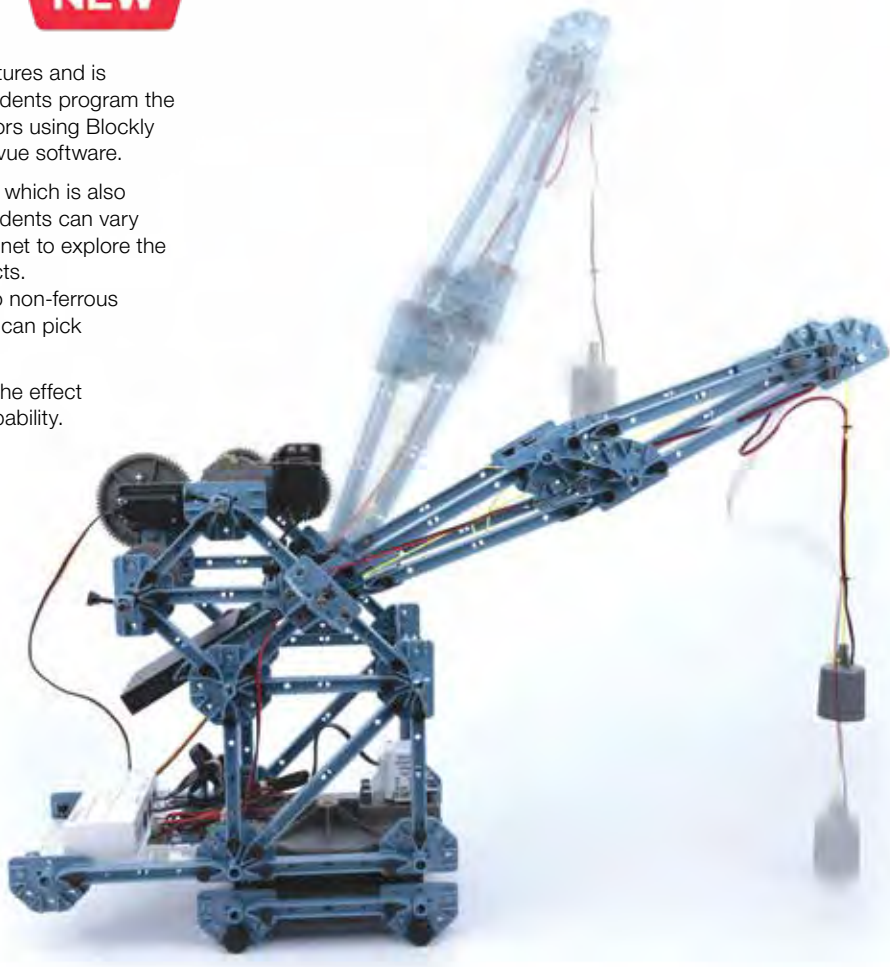

### Includes:

- //control.Node (PS-3232)
- //code.Node (PS-3231)
- Low Speed Stepper Motor (PS-2978)
- Power Output Module (PS-3324)
- Servo Motor (2) (SE-2975)
- Gear Set (ME-7021)
- Turntable (ME-7024)
- Electromagnet (ME-7027)
- Structures I-Beams (45)
- Structures Connectors (26)
- Structures Counterweight (ME-7037)
- Truss Set Screws (2 sets of 75) (ME-6994)
- Axles (4)
- Small Pulley (2)
- Motor Mount (set of 2) (ME-7020)
- Spool and Bearings (2) (ME-7022)
- //control.Node Platform (ME-7042)
- 0.625-inch Steel Ball (2)
- Storage Box



### Order Information

Motorized Crane .....ME-7030

## Motorized Drawbridge

**NEW**

ME-7028

Build this drawbridge from PASCO Structures, add a stepper motor and gears, and raise and lower it using code you write. This bridge kit also includes a Wireless Load Cell/Accelerometer that can be used to measure forces within the bridge while it moves.

### Activities:

- Build the drawbridge.
- Raise and lower the drawbridge.
- Measure forces in top and bottom beams.
- Measure support forces.
- Explore the effect of the counterweight on motor acceleration.
- Explore the effects of different gear ratios.
- Use the load cell as a limit switch.
- Operate the drawbridge in response to a signal.

```

set stepper using units rev/s
for //control.Node :
  configure port A
  rotate stepper through
    angle (rev) 0.9
    to max ±speed (rev/s) -0.33
    with acceleration (rev/s²) 0.02
  Wait for completion
  sleep for 3000 ms
    
```



Students write Blockly code to control the drawbridge motion.

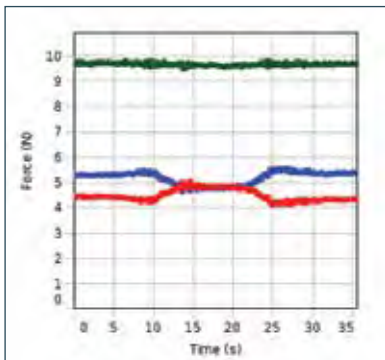

The load on the front bridge support (blue), the load on the back bridge support (red), and the total of the two loads (green) are plotted in real time as the bridge is raised and lowered.



### Includes:

- //control.Node (PS-3232)
- Wireless Load Cell and Accelerometer (PS-3216)
- Low Speed Stepper Motor (PS-2978)
- Gear Set (ME-7021)
- Structures Counterweight (ME-7037)
- Structures I-Beams (40)
- Structures Connectors (18)
- Structures 6-32 Screws (100)
- Structures Long Axle (1)
- Motor Mount (1)
- Storage Box

### Order Information

Motorized Drawbridge .....ME-7028

## StructureBOT Kit

ME-7029

**NEW**

The StructureBOT is built by students using PASCO Structures. The stepper motors and servo motors that make it move are controlled using a //control.Node connected to a computer through Bluetooth®. Students program the bot using Blockly coding embedded in PASCO Capstone or SPARKvue software.

### Activities:

- Build the StructureBOT.
- Move the Bot forward and backward.
- Turn the Bot.
- Power steer the front wheel.
- Move objects with the Gripper.
- Build a two-wheel Bot.

### Further Exploration:

- Add a Wireless Motion Sensor to avoid obstacles.
- Add two Light Sensors to follow a line.
- Add a //code.Node to steer the Bot.
- Add a //code.Node for turn signals.
- Add a Wireless Light Sensor to sort colored objects.

### Features:

- Multiple configurations: With and without the gripper, two wheels or three wheels, front-wheel steering or dual back-wheel steering
- Expandability: Add other PASCO Structures components to change the StructureBOT's design
- Expandability: Add other PASCO sensors to expand the bot's capabilities



### Includes:

- //control.Node (PS-3232)
- High Speed Stepper Motor (2) (PS-2976)
- Servo Motor (2) (SE-2975)
- Structures Gripper (ME-7025)
- Gear Set (ME-7021)
- Caster Wheel (ME-7023)
- Structures Hinge (ME-7026)
- Truss Set Screws (set of 75)
- Structures I-Beams (14)
- Structures Connectors (7)
- Structures Full-Round Connector (2)
- Structures Wheels with Tires (2)
- Structures Medium Axle
- Motor Mount (3)
- //control.Node Platform

### Order Information

StructureBOT .....ME-7029

## Motor Mount (Set of 2)

**NEW**

ME-7020

Mount motors to PASCO Structures using the Motor Mount. The Motor Mount fits either a PASCO Stepper Motor or regular size servo motor.

The included spline shaft adapter fits onto the spline of the motor to create a shaft that fits through a hole in the Motor Mount. The motor attaches to the motor mount with four screws. The Motor Mount has the same connection features (pin and screw hole) that the Structures I-beams have so it can be attached to any Structures connector.

The Motor Mount is also used to mount the gripper arms on the Structures Gripper.



Order Information	
Motor Mount (Set of 2).....	ME-7020

## Spool and Bearings

**NEW**

ME-7022

This two-step spool is used to make a powered winch with PASCO Structures. The spool is secured onto a Structures axle with the included anti-backlash screw. The axle passes through the two included plastic bearings that are screwed to the Structures connectors. These bearings ensure smooth rotation of the axle.

String can be wrapped around either step of the spool to explore the difference in speed and torque made by the spool's diameter.



Order Information	
Spool and Bearings.....	ME-7022

## Gear Set

**NEW**

ME-7021

These three pairs of gears are driven by stepper motors or servo motors to make PASCO Structures move. These three pairs enable three different gear ratios (1:1, 2:1, 4:1) with the same shaft separation, making it easy to change gear ratios.

The gears are secured on the motor shaft or PASCO Structures axles using the included anti-backlash screws.

The 60T and 72T gears have the hole and threaded hole features that allow a Structures I-beam to be attached directly to the gear.



Order Information	
Gear Set .....	ME-7021

## Caster Wheel

**NEW**

ME-7023

The Caster Wheel is part of the Motorized StructureBot but can also be purchased separately to add to your own PASCO Structures designs.



## Turntable

**NEW**

ME-7024

The Turntable is designed to rotate cranes made from PASCO Structures. Add a stepper motor to drive the gear mechanism. Connect any structure built with a square composed of #3 I-beams and connectors.



Order Information	
Caster Wheel .....	ME-7023
Turntable .....	ME-7024

## Structures Gripper

**NEW**

ME-7025

Add the Gripper to PASCO Structures to grab objects. Attach a stepper motor or servo motor to the Gripper to drive the gear that opens and closes the Gripper arms. The Gripper has the same pin and screw features used to connect a Structures I-beam to a connector, making it easy to attach the Gripper to any existing PASCO Structure.

### Features:

- Gripper mounts to PASCO Structures using the same pin and screw features that are used to connect an I-beam
- Elastic bands add gripping friction
- The //control.Node can detect the increase in servo current so you can tell when the Gripper has closed on an object.



Order Information	
Structures Gripper .....	ME-7025

## Structures Hinge

**NEW**

ME-7026

Use the Hinge with the Structures to make movable joints. The Hinge is designed to be used with the PASCO Structures axles and the Hinge can be locked into place on the axle with two screws. The Hinge has attachment features for up to three Structures I-beams.



## Structures Counterweight

**NEW**

ME-7037

The Counterweight is used to offset the weight of drawbridges and cranes, making them more balanced and requiring less torque to move. Each side has a 6-32 threaded hole and two non-threaded holes that match the same form factor as the Structures I-beam connectors. This allows the Counterweight to be held onto the Structures using I-beams and 6-32 screws.



Order Information	
Structures Hinge.....	ME-7026
Structures Counterweight .....	ME-7037



## Electromagnet

**NEW**

ME-7027

This Electromagnet can be attached to a winch on a Structures crane to pick up objects. The Electromagnet is powered using a Power Output Module plugged into a //control.Node.

The Electromagnet includes steel washers and stickers to attach to an object so the Electromagnet will be able to pick up a non-ferrous object such as a paper cup.

Vary the power to the Electromagnet by varying the duty cycle of the applied 5 volts.



Order Information	
Electromagnet .....	ME-7027



**Biology** Educational solutions for General, AP®, IB®, and Honors Biology courses

**Hands-On Solutions for Your Biology Lab**

Engage your biology students in the thrill of discovery with world-class solutions from PASCO. Our reliable sensors, labs, and software empower students to think like real-life biologists as they form hypotheses, investigate phenomena, and analyze data to make sense of the world around them. With flexible solutions for General, AP®, IB®, and Honors Biology courses, you're sure to find a PASCO solution that's right for you.

**Biology Index**

Biology Starter Lab Station ..... 37

Advanced, AP® & IB® Biology ..... 38

Weather with GPS and Soil Moisture..... 40

Temperature and pH..... 41

Conductivity and Pressure..... 42

Light, Diffusion/Osmosis ..... 43

CO<sub>2</sub> and O<sub>2</sub> ..... 44

Optical Dissolved Oxygen and Photosynthesis Tank.. 45

EcoZone System and Colorimeter/Turbidity..... 46

Wireless Spectrometer and UV-Vis Spectrometer ..... 47

Hand-Grip & Exercise Heart Rate, Blood Pressure .... 48

Spirometer and EKG ..... 49

AirLink Interface and Human Eye Model ..... 50

Digital Microscopes & Microscope Cameras..... 51

**World Class Support and Professional Development - Committed to Your Success!**

We want you to have all the support, guidance, and training you need. Just let us know how we can help.

# Biology Starter Lab Station

EB-6334

The Biology Starter Lab Station makes it easy and affordable to begin using sensor-based technology in your biology lab or classroom. Designed for convenience, the Biology Lab Stations contain the wireless sensors used to perform 10 Biology labs, plus many of the labs in our Essential Biology Lab Manual. The ten explorations range from the cellular to organismal level and investigate processes such as respiration, photosynthesis, enzymatic activity, membrane permeability and osmosis. Students can also investigate cell size, body regulation, and the impacts of environmental factors on reaction rates and organism responses.



## Biology Station Lab Titles

The Biology Starter Lab Station supports 7 of the 10 labs. Add the Extension Lab Station\* to do all 10 lab titles.

### 1. Enzyme Action

### 2. Membrane Permeability

### 3. Osmosis

### 4. Plant Respiration & Photosynthesis\*

### 5. Respiration of Germinating Seeds

### 6. Acid Rain

### 7. Regulation of Body Heat

### 8. Plant Pigments\*

### 9. Cell Size\*

### 10. Cellular Respiration in Yeast

The Biology Starter Lab Station includes these wireless sensors and materials:

- Temperature
- Pressure
- pH
- CO<sub>2</sub>
- Storage Case
- Lab Manual

*\*To do the remaining 3 labs listed above and another 4 labs from the Essential Biology Lab Manual, add the Extension Lab Station (see page 35) and the Essential Biology Through Inquiry Lab Manual.*



The Biology Starter Lab Station

## Order Information

Biology Starter Lab Station.....EB-6334

Essential Biology Teacher Lab Manual.....EB-6331



## Essential Biology Teacher Lab Manual

EB-6331

This printed lab manual includes 23 lab activities that can be edited to suit the needs of your students or to better coordinate with your classroom lectures. Each complete investigation includes a teacher guide and student handout. Student handouts include procedural instructions, blank graphs and tables for data entry, as well as analysis questions with space for students to record their answers. Each investigation is tightly integrated with our innovative software, sensors, and equipment.

- Enzyme Action (Pressure Sensor)
- Enzyme Action (Oxygen Sensor)
- Membrane Permeability
- Organisms and pH
- Osmosis
- Plant Respiration and Photosynthesis
- Respiration of Germinating Seeds
- Buffers in Biological Systems
- Acid Rain
- Cellular Respiration in Yeast
- Energy Content of Food
- Metabolism of Yeast
- Photosynthesis of Aquatic Plants
- Soil pH
- Transpiration
- Water and pH
- Water Purification
- Weather in a Terrarium
- EKG: Factors that Affect the Heart
- Exercise and Heart Rate
- Exercise and Blood Pressure
- Muscle Strength
- Regulation of Body Heat
- Volume of Breath

# Advanced Biology Through Inquiry Labs for AP<sup>®</sup> & IB<sup>®</sup>

PASCO's award-winning Advanced Biology through Inquiry Teacher Guide is newly revised and contains 18 labs that have been specifically designed to support student inquiry, as well as AP<sup>®</sup> and IB<sup>®</sup> curriculum\*. This manual is available in a print version and an all-digital version.

- Most labs can be completed in one lab session with readily available materials, including the Biology Lab Stations on the opposite page.
- Easy and meaningful data collection leads to increased time for data analysis and discussion.
- Labs integrate high-order analysis and synthesis questions.
- Includes sample data for investigations and inquiry, answers to analysis and synthesis questions, an assessment rubric, teacher tips, lab preparation information, and more.

Advanced Biology Lab Experiments	Starter Lab Station (EB-6334)	Starter and Extension Lab Stations (EB-6334, EB-6335)	IB <sup>®</sup> Standards*	Targeted AP <sup>®</sup> Learning Objectives*
1A. Enzyme Activity (Oxygen)	●	●	2.5	1-2.B; 2-1.F; 2-1.G; 4-3.A
1B. Enzyme Activity (Pressure)		●	2.5	1-2.B; 2-1.F; 2-1.G; 4-3.A
1C. Enzyme Activity (Spectrometer)**		●	2.5	1-2.B, 2-1.F, 2-1.G, 4-3.A
2. Diffusion	●	●	1.4; 10.3	2-1.C; 2-2.C; 2-2.F; 2-2.I
3. Osmosis		●	1.4	2-1.C; 2-2.C; 2-2.F; 2-2.H; 2-2.I; 2-3.A; 2-3.B; 2-3.D; 3-3.A; 3-3.B
4. Plasmolysis		●	1.4	2-2.D; 2-2.F; 2-2.H; 2-2.I
5. Cell Size		●	1.1	1-2.B; 2-1.A; 2-1.B; 2-2.I
6. Homeostasis	●	●	N/A	2-1.M; 2-3.A; 2-3.B, 2-3.D; 3-3.A; 4-3.D
7. Cellular Respiration	●	●	2.8	1-2.B; 2-1.H; 2-1.K; 2-2.K; 4-1.E; 4-1.F
8. Photosynthesis	●	●	2.9	2-1.A; 2-1.I; 2-1.J; 2-1.O; 4-3.A
9. Plant Pigments		●	2.9	2-1.A; 2-1.J; 2-1.J; 2-2.A; 2-2.K; 2-4.C; 4-1.F; 4-3.A
10. Transpiration	●	●	9.1	2-1.A; 2-2.H; 2-2.I; 2-3.A; 2-3.D; 4-3.D
11. Mitosis	<b>No sensors required</b>		1.6	3-1.B; 3-1.C; 3-1.D; 3-1.K
12. Meiosis			3.3; 10.1	3-1.F; 3-1.G; 3-1.H; 3-1.I; 3.1K; 3-4.A; 4-3.C
13. Energy Dynamics	●	●	4.2	2-1.A; 2-1.H; 2-1.I; 2-4.B; 4-1.G
14. Artificial Selection	<b>No sensors required</b>		N/A	1-1.C; 1-1.D; 1-1.E; 1-1.F; 1-3.A
15. BLAST Bioinformatics			3.1; B.5	1-1.H; 1-1.M; 1-1.N; 1-2.B; 1-2.C; 1-3.A; 1-3.B; 1-3.C
16. Population Genetics			10.3	1-1.C; 1-1.H; 1-1.I; 1-1.K; 1-1.M
17. Mathematical Modeling of Evolution			10.3	1-1.C; 1-1.E; 1-1.H; 1-1.K; 1-1.L; 1-3.A
18. Animal Behavior			A.4	2-3.D; 2-4.B; 3-5.A; 4-1.G

\* AP is a registered trademark of the College Board, which was not involved in the production of, and does not endorse, this product. IB is a registered trademark of the International Baccalaureate Organization, which was not involved in the production of, and does not endorse, this product.

\*\* Requires Spectrometer (PS-2600), sold separately.

## Order Information

Advanced Biology Through Inquiry Teacher Guide ..... PS-2852A

Includes lab prep instructions, expected answers/results, and editable student files. Manual is available in eco-friendly digital format or in print.





# Biology Lab Stations Support Advanced Biology

The Biology Starter and Extension Lab Stations, together with PASCO's *Advanced Biology Through Inquiry Lab Manual*, offer a truly complete Biology solution. With over 25 sensor-based labs that cover a range of Biology and Advanced Biology topics, plus all of the equipment and apparatus required to conduct the labs hands-on, inquiry with data collection and analysis has never been easier or more affordable. For investigations in Physiology, add the Physiology Bundle and extend your studies even further.



## Biology Station Lab Titles

Together, the Biology Starter and Extension Lab Stations support over 20 Advanced Biology labs. Conduct the 10 labs below right out of the box.

### 1. Enzyme Action

### 2. Membrane Permeability

### 3. Osmosis

### 4. Plant Respiration & Photosynthesis

### 5. Respiration of Germinating Seeds

### 6. Acid Rain

### 7. Regulation of Body Heat

### 8. Plant Pigments

### 9. Cell Size

### 10. Cellular Respiration in Yeast



Biology Starter (left) and Extension Lab Stations (right)

The Biology Starter & Extension Lab Stations include these wireless sensors and materials:

- Temperature
- Pressure
- pH
- CO<sub>2</sub>
- Storage Case
- Lab Manual\*
- Optical Dissolved Oxygen
- Colorimeter & Turbidity
- Conductivity Sensor
- EcoChamber



## Physiology Extension Bundle

PS-2935D

The Physiology Extension Bundle enables students to study the heart cycle, lung function, human respiration, stimulus and response, homeostasis, and more! This bundle includes a Wireless EKG Sensor, a Wireless Spirometer, Spirometer Mouth Pieces, a Wireless Blood Pressure Sensor with Standard Cuff, and a Wireless Hand-Grip Heart Rate Sensor.

1. Wireless EKG Sensor PS-3236
2. Hand-Grip Heart Rate PS-3206
3. Wireless Blood Pressure PS-3218
4. Wireless Spirometer PS-3234
5. Spirometer Mouth Pieces PS-2522



## Order Information

- Biology Starter Lab Station.....EB-6334  
 Biology Extension Lab Station .....EB-6335  
 Wireless Physiology Extension Bundle.....PS-2935D

*Biology Starter and Extension Lab Stations come standard with 10 Essential Biology Through Inquiry Labs. The Advanced Biology Through Inquiry Lab Manual is sold separately (see page 38 for order information).*



## Wireless Weather Sensor with GPS

PS-3209

The Wireless Weather Sensor is an all-in-one instrument for monitoring complex environmental conditions. It houses several sensing elements within a single unit to provide 19 different measurements. Use the sensor in logging mode with the Weather Vane Accessory for long-term monitoring, or use it as a handheld instrument to study microclimates and local phenomena. The collected data can be wirelessly exported to most devices, including classroom device dashboards, making it easier to support group activities that are constrained by time. Plus, with the built-in GPS, students can collect and analyze location data using the SPARKvue map display, powered by ESRI ArcGIS.



Student-friendly weather dashboard to visualize its multiple sensors.

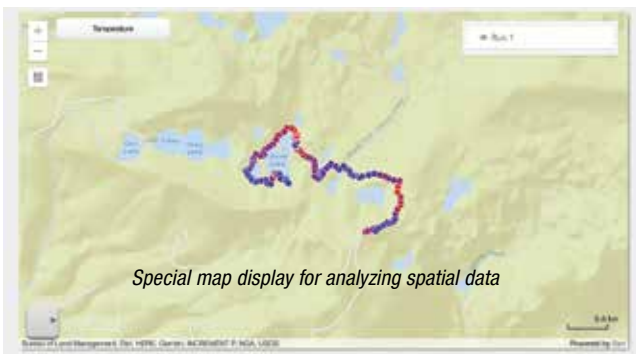

Special map display for analyzing spatial data



With ESRI's ArcGIS online you can visualize data in seconds with a FREE account!



Weather Vane Accessory sold separately.

### Order Information

Wireless Weather Sensor with GPS .....PS-3209

Wireless Weather Sensor with GPS Pack .....PS-3340

*Note: Price for multi-sensor packs includes 8 sensors and custom storage case.*

Weather Vane Accessory .....PS-3553

## Wireless Soil Moisture Sensor

PS-3228

The Wireless Soil Moisture Sensor measures the volumetric water content (%VWC) of soil, reporting data in real time or storing it onboard the sensor's memory for long-term experiments. Durable and easy to use, the Wireless Soil Moisture Sensor is the perfect tool for monitoring controlled experiments in the classroom and long-term experiments outdoors. From experiments in evaporation and soil composition to water consumption and plant competition, the Wireless Soil Moisture Sensor makes it easy for students to investigate a wide array of topics over the course of minutes, hours, or days!

### Features:

- Collect and display data in real time within PASCO Capstone or SPARKvue software
- Automate data collection for hours, days, or weeks with remote Logging Mode
- Bluetooth connectivity enables use in the classroom, lab, or field
- Supports use of GPS data from a mobile device for GIS mapping activities
- Selectable calibrations for predominantly sandy soils, clay soils, and loamy soils



### Order Information

Wireless Soil Moisture Sensor .....PS-3228



## Wireless Temperature Sensor

PS-3201

Welcome to the modern thermometer. The Wireless Temperature Sensor transmits live data and allows students to continuously monitor, log, and plot temperature measurements on nearly any device. When lab-time ends but the experiment continues, students can set the sensor to log data autonomously for days, weeks, or months, then download it for analysis later. This durable, wireless sensor features a stainless steel probe for the most demanding of applications, as well as a battery that lasts over a year\*. It can be used in a wide array of experiments and activities because it measures small, but significant temperature changes produced by chemical reactions, convection currents, and even skin temperatures.

### Features:

- Simply pair and go, no cables or adapters to manage
- Variable sampling rate for capturing small, fast changes or experiments that run for hours, days, or weeks
- Bluetooth® connectivity and long-lasting coin cell battery
- Logs temperature data directly onto the sensor for long-term experiments
- Dust, dirt, and sand-proof and water resistant (IP-X7 certified)

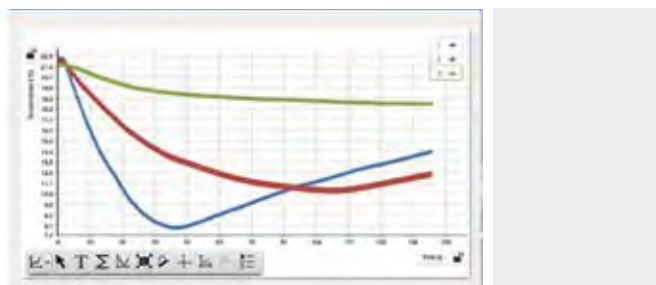

### Order Information

- Wireless Temperature Sensor.....PS-3201
- Wireless Temperature Sensor Pack.....PS-3330

**Note:** Price for multi-sensor packs includes 8 sensors and custom storage case.

## Wireless pH Sensor

PS-3204

The Wireless pH Sensor is a must-have for any chemistry, biology, or environmental science course. Equally capable in the lab or field, the sensor eliminates the hassle of cables, reducing spills and improving safety. Plus, it rarely requires charging; the sensor's coin cell battery lasts for 2-3 years in most labs and costs about one dollar to replace. It can transmit data in real time, or store data for days when continuous monitoring is required. The Wireless pH Sensor enhances countless activities, including acid-base titrations, investigations into household chemicals, analyses of chemical reactions, water quality studies, and much more.

### Features:

- Simply pair and go, no cables or interfaces to manage
- Compatible with ion-selective electrodes (ISE) and the oxidation reduction probe (ORP)
- Bluetooth® connectivity and a long-lasting coin cell battery
- Logs pH data directly onto the sensor for long-term experiments
- Wirelessly connects to SPARKvue and PASCO Capstone for convenient analysis and lab reports

*SPARKvue lets students get the most out of their measurements, displaying them as digits, graphs, tables, or bar charts.*



### Order Information

- Wireless pH Sensor.....PS-3204
- Wireless pH Sensor Pack.....PS-3331

**Note:** Price for multi-sensor packs includes 8 sensors and custom storage case.



## Wireless Conductivity Sensor

PS-3210A

The Wireless Conductivity Sensor measures the electrical conductivity of an aqueous solution. It is ideal for investigating the properties of solutions, including total dissolved solids (TDS) for water quality inquiry. Because it is temperature compensated, calibrations are less frequent and can be applied across a range of temperatures. With an improved range of 0 to 40,000  $\mu\text{S}/\text{cm}$ , this sensor can be utilized for chemical, biological, and environmental studies.

Teacher tip: To measure brackish or marine samples, perform a dilution until the measurement falls within the range, then multiply to determine sample conductivity.

### Features:

- Measure conductivity and total dissolved solids
- Automatic temperature compensation
- Battery life >1 year
- Remote logging with built-in memory
- Dust-proof, sand-proof, and water-resistant (1 meter for 30 minutes)



### Order Information

Wireless Conductivity Sensor .....PS-3210A

Wireless Conductivity Sensor Pack.....PS-3332

**Note:** Price for multi-sensor packs includes 8 sensors and custom storage case.



## Wireless Pressure Sensor

PS-3203

The Wireless Pressure Sensor allows students to easily collect accurate gas pressure data for a wide range of applications. Included is a 60cc syringe, tubing, and connectors that facilitate experiments such as Boyle's Law or measuring pinch-grip strength. Within PASCO's software, students can easily select their desired units from a list containing kPa, mmHg, inHg, mbar, psi, atm, and torr.

### Features:

- Measures pressure even when the pressure within the system drops below ambient pressure
- Supports common units (kPa, atm, psi, mmHg, or  $\text{N}/\text{m}^2$ ) for many applications
- Bluetooth® connectivity and long-lasting rechargeable battery

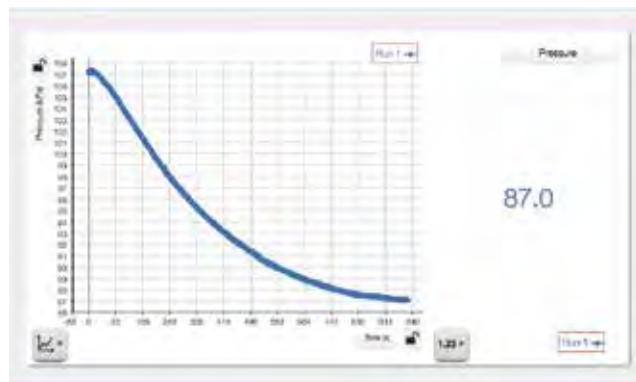

### Order Information

Wireless Pressure Sensor .....PS-3203

Wireless Pressure Sensor Pack.....PS-3333

**Note:** Price for multi-sensor packs includes 8 sensors and custom storage case.



## Wireless Light and Color Sensor

PS-3248

The Wireless Light and Color Sensor features two separate apertures: One measures ambient light from the side of the box, and the other measures percent color of directional light at the end of the box.

### Features:

- Wirelessly connects to computers, Chromebooks, tablets, and smartphones
- Simply pair and go, no cables or adapters to manage
- On-board memory enables the sensor to function as an independent datalogger
- Variable sampling rate for short, precise experiments or lengthy, multi-day data collection
- Bluetooth® connectivity and long-lasting coin cell battery
- Indirect PAR measurements for biological studies



### Order Information

Wireless Light and Color Sensor.....PS-3248  
 Wireless Light Sensor Pack.....PS-3338

**Note:** Price for multi-sensor packs includes 8 sensors and custom storage case.



## Diffusion/Osmosis Kit

ME-6942

It is an image that appears in practically every biology text to help students with conceptual understanding: a U-shaped tube with a permeable membrane separating a hypotonic and hypertonic solution. And yet few classroom methods of studying osmosis take advantage of this simple and elegant design for lab work.

### Features:

- Plastic rather than glass columns for durability and student safety
- Free standing unit requires no additional lab equipment to hold it in place
- Air tight joints prevent pressure leaks
- Membranes are quick and easy to replace when compromised
- Graduated transparent columns allow changes in volume to be seen and quantified
- The U-shaped design provides familiarity for students and the straight columns keep the volume of gas above the fluid constant
- Great for determining colligative effects on osmotic pressure

## Wireless Temperature Sensor Link

PS-3222

The Wireless Temperature Sensor Link enables wireless connection for any PASCO temperature probe with a 3.5 mm connection. The link comes with a Fast Response Temperature Probe, but it can also connect to the Stainless Steel Temperature Probe, Skin/Surface Temperature Probe, the Absolute Zero Sphere, and the Ideal Gas Law Apparatus.



### Order Information

Diffusion/Osmosis Kit.....ME-6942  
 Wireless Temperature Sensor Link.....PS-3222



## Wireless CO<sub>2</sub> Sensor

PS-3208

Measure changes in carbon dioxide (CO<sub>2</sub>) gas levels quickly and easily with the Wireless CO<sub>2</sub> Sensor. This temperature-compensated sensor can operate in high humidity environments and employs live data to make core labs, such as photosynthesis, cellular respiration, and metabolism experiments engaging and impactful. With the ability to store more than 55,000 data points, the Wireless CO<sub>2</sub> Sensor also supports long-term studies of carbon cycling that span the course of a single night or an entire weekend. Includes 250-mL sample bottle that allows gases to be analyzed with multiple sensors.

**Features:**

- Logging ability for long-term experiments, store up to 55,000 data points
- Integrated stopper for use with included sample bottle and common glassware
- Temperature compensated for increased accuracy



**Order Information**

Wireless CO<sub>2</sub> Sensor (Carbon Dioxide) .....PS-3208

Wireless CO<sub>2</sub> Sensor Pack .....PS-3341

*Note: Price for multi-sensor packs includes 8 sensors and custom storage case.*

## Wireless Oxygen Gas Sensor

PS-3217

The Wireless Oxygen Gas Sensor measures gaseous O<sub>2</sub> concentrations as well as humidity and air temperature for a range of biology, environmental science, and physiology activities.

The Wireless Oxygen Gas Sensor is accurate and easy to use, making it the perfect sensor for studying photosynthesis, respiration, and oxygen cycling in a closed or open system. With remote logging, experiments can go beyond the lab period and easily give students hours or days of data for analysis. In addition to measuring oxygen gas levels, the Wireless Oxygen Gas Sensor also contains sensors to measure ambient temperature and humidity.

**Features:**

- Bluetooth® and USB connectivity
- 0-100% Oxygen Gas Concentration
- ±1% Oxygen at constant temperature and pressure
- Also reports ambient temperature and humidity
- 2-3 year operating life with replaceable sensing element

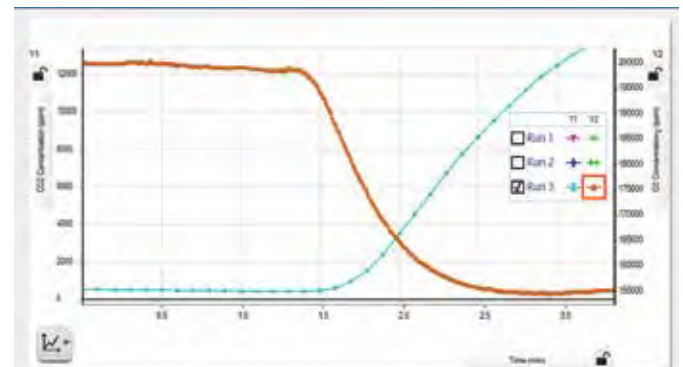

## Metabolism Chamber

ME-6936

The Metabolism Chamber is a 250 mL sample bottle with 2 holes cut specifically for PASCO gas sensors to allow simultaneous measurements of carbon dioxide gas and oxygen gas.



**Order Information**

Wireless Oxygen Gas Sensor .....PS-3217

Metabolism Chamber .....ME-6936



## Photosynthesis Chamber

PS-3251

PASCO's Wireless Optical Dissolved Oxygen Sensor (PS-3246) allows students to monitor most common photosynthesis experiments. Typical experiments require students to infer photosynthetic rate changes by using chloroplasts and dye. Help your students better understand photosynthesis via direct measure of oxygen while controlling light, temperature or nutrients. Ideal for exploring aquatic plants, algal beads, and even the consumption of oxygen by respiration.

The lid features three convenient ports for sensors; stoppers are included to maintain a closed system. The ports will accommodate Wireless Temperature Sensor (PS-3201), Wireless Conductivity (PS-3210A), Wireless pH Sensor (PS-3204) or other ion selective electrodes for additional measurements. A clear inner chamber allows full sunlight exposure, or set into an outer cover chamber to block out light.



Dual chambers allow sample to set in temperature controlling water bath.

Nine separate LED lights (white, red, green or blue) allow students to test these variables and others such as plant nutrient uptake and elimination

### Order Information

Photosynthesis Chamber .....PS-3251

## Wireless Optical Dissolved Oxygen Sensor

PS-3246

The Wireless Optical Dissolved Oxygen (ODO) Sensor is ideal for monitoring DO<sub>2</sub> in the lab or field. The Wireless Optical DO Sensor contains three different probes. In addition to the dissolved oxygen sensor, it also includes probes for measuring atmospheric pressure and water temperature. The optical technology is accurate, fast, and does not require stirring, filling solutions, warm-up, or frequent calibration.

**NOTE:** The included waterproof probe is submersible to a depth of 2.5m. The (white) wireless sensor box is not waterproof.



### Order Information

Wireless Optical Dissolved Oxygen Sensor (NEW!)PS-3246

## EcoZone System

ME-6668

PASCO's EcoZone System is designed to help students model and understand complex interactions within, and among, different ecosystems. The three clear, acrylic EcoChambers are specially designed to accommodate PASCO sensors, making qualitative and quantitative measurements easily accessible. The three chambers connect to allow students to study up to three different ecosystems.

### Features:

- Total volume of each chamber is 4534 cubic centimeters
- Sturdy construction designed for easy setup and cleanup
- Quantitatively study the interaction of different ecosystems
- Custom molded for use with PASCO sensors
- Clear acrylic allows for observations from all sides

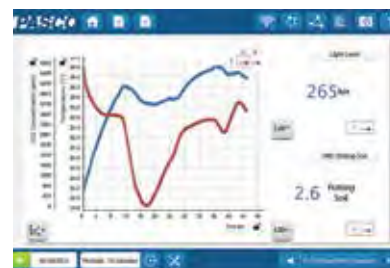

### Order Information

EcoZone System .....ME-6668  
EcoChamber .....ME-6667



## Wireless Polarimeter

PS-3237

The Wireless Polarimeter has both Bluetooth® and USB connectivity, making it possible to analyze chiral compounds with your iPad®, Chromebook™, Android tablet, or computer. It is ideal for introductory experiments in Organic Chemistry and Biochemistry, where chiral compounds are of special interest.

PASCO's Wireless Polarimeter passes plane polarized light through a vertical sample, which contains a chiral compound, followed by an analyzer and detector. The optical rotation is determined by finding the angle between the starting position and the location where the optimum light level transmits through the cross polarizer. Students can use the rotation data to calculate the concentration of a chiral sample, while the specific rotation (amount turned per g/ml dissolved) is an intrinsic property that can be used to differentiate molecules or determine racemic mixtures.

### Specifications:

- **Connectivity:** Bluetooth and USB
- **LED light source:** 589 nm
- **Optical Rotation Accuracy:**  $\pm 0.09^\circ$
- **Cell Length:** 101.3mm  $\pm$  0.8mm

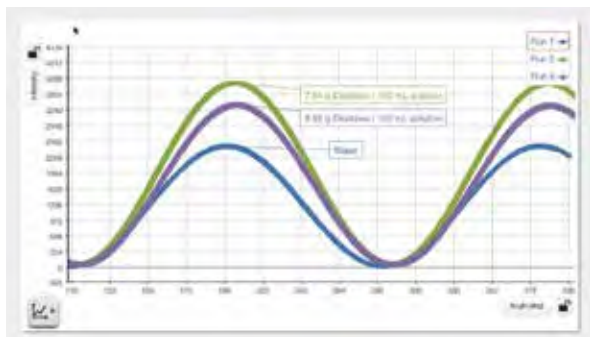

### Order Information

Wireless Polarimeter .....PS-3237



## Wireless Colorimeter & Turbidity Sensor

PS-3215

The Wireless Colorimeter & Turbidity Sensor simultaneously measures the absorbance and transmittance of six different wavelengths. The sensor can be used to study Beer's Law (absorbance vs. concentration), enzyme activity, photosynthesis, and the rates of chemical reactions (absorbance vs. time). After a simple calibration, students can quickly begin viewing live measurements as they materialize across the visible spectrum at 650 nm (red), 600 nm (orange), 570 nm (yellow), 550 nm (green), 500 nm (blue), and 450 nm (violet).

This sensor also functions as a high-quality turbidimeter for water quality analysis. Rather than simply measuring transmitted light, the Wireless Colorimeter and Turbidity Sensor measures light scattered at a 90° angle from the sample, resulting in accurate and repeatable measurements. When used with our ezSample water test kits, chemical concentrations can be determined using the calibration curves included in PASCO software.

### Features:

- Stabilized light source for consistent readings
- PASCO software displays the absorbance & transmittance at each wavelength in the appropriate color
- Quick and easy calibration
- Functions as both a colorimeter and turbidimeter
- Built-in calibrations report concentrations of Ammonia, Nitrate, Phosphate, and Iron in parts per million using ezSample Kits.



Measure the absorbance and transmittance of a solution at six different wavelengths... simultaneously!

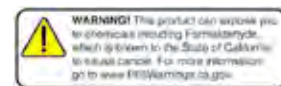

### Order Information

Wireless Colorimeter & Turbidity Sensor .....PS-3215

Includes USB charging cable, 9 cuvettes, 2 cuvette racks, and one 100 NTU calibration cuvette.

Wireless Colorimeter & Turbidity Sensor Pack .....PS-3334

**Note:** Price for multi-sensor packs includes 8 sensors and custom storage case.





## UV-Vis Spectrometer

SE-3607

The SE-3607 is an easy-to-use, wide range UV-Vis spectrometer that delivers fast, accurate and reliable performance for routine analyses in chemistry and biochemistry teaching labs. With USB connectivity and cross-platform Spectrometry Software, the PASCO UV-Vis Spectrometer improves collaboration between lab members, enabling data collected on a computer or laptop to be analyzed on tablets, iPads, and Chromebooks\*. Additional accessories, such as the Quartz Fiber Optic Cable Set, can be used to extend the spectrometer's capabilities for the analysis of emission spectra, light sources, and the classification of lasers.

### Highlights:

- Spectral scans from 180 to 1050 nm
- Award-winning Spectrometry software
- One-click light and dark calibrations
- Adjustable scan averaging, signal integration time, and smoothing
- Displays entire spectra with each scan
- Graphs Absorbance vs. Wavelength
- Graphs Intensity vs. Wavelength (emission spectra)
- Graphs Absorbance vs. Concentration (Beer's Law)
- Graphs Absorbance vs. Time (kinetics)

## Wireless Spectrometer (VIS)

PS-2600A

The award-winning PASCO Wireless Spectrometer is specifically designed for modern chemistry, biology, and physics labs. It connects to student devices via USB or Bluetooth Low Energy and includes free Spectrometry software with built-in tools for spectral analysis. Scan times are fast, enabling students to collect a full spectrum of data in less than a second. Three plots are provided for common applications, including Absorbance vs. Wavelength (or Intensity vs. Wavelength), Absorbance vs. Concentration (Beer's law), and Absorbance vs. Time (kinetics).

### Perform these labs with the PASCO Spectrometer:

- Photosynthesis with DPIP
- Absorption spectra of plant pigments
- Concentration of proteins in solution
- Rate of an enzyme-catalyzed reaction
- Growth of a cell culture



Includes USB charging cable, 10 cuvettes, and Spectrometry Software.



Semi-Micro Volume Cuvettes (Qty. 10), Cuvette Rack (EC-3590), USB-A to USB-B Cable, External AC Adapter, 24 V Power Supply, Foam Lined Carrying Case (ABS).

UV Quartz Cuvettes (Qty. 2)



Sold Separately

UV-Vis Fiber Optic Cable Set



Sold Separately

### Order Information

Wireless Spectrometer (Vis) .....PS-2600A

### Order Information

UV-Vis Spectrometer .....SE-3607  
 UV Quartz Cuvettes (Qty. 2) .....SE-3611  
 UV-Vis Fiber Optic Kit .....SE-7182



## Wireless Hand-Grip Heart Rate Sensor

PS-3206

With these wireless hand grips, conducting physiology labs on the cardiovascular system or homeostasis is easier than ever before. Continuously monitor heart rate during exercise, or use the sensor to take initial and final measurements with fast and reliable heart rate detection.



### Order Information

Wireless Hand-Grip Heart Rate Sensor .....PS-3206

## Wireless Exercise Heart Rate Sensor

PS-3207

The Wireless Exercise Heart Rate Sensor has a chest strap and will transmit data wirelessly up to 10 m away! The electrode belt fits around the ribcage (worn against the skin for best results, but can be worn over a shirt if a drop of saline solution is applied under the electrodes). Live and recorded data can be analyzed using any device with PASCO software installed.



### Order Information

Wireless Exercise Heart Rate Sensor .....PS-3207



## Wireless Blood Pressure Sensor with Standard Cuff

PS-3218

PASCO's Wireless Blood Pressure Sensor allows students to quickly and easily measure both systolic and diastolic arterial blood pressure (mmHg) as well as heart rate (pulse in bpm). Comparing the digits display for systolic and diastolic pressure with the display of blood pressure from the real-time graph helps students gain a contextual understanding of the physiology of blood pressure.



Observe heart rate plus systolic and diastolic blood pressure



### Order Information

Wireless Blood Pressure Sensor with Standard Cuff.....PS-3218



## Wireless Spirometer

PS-3234

The Wireless Spirometer Sensor makes it safe and easy for students to collect respiratory measurements, including flow rate, pressure, and lung volume. Ideal for studies in health and human physiology, the Wireless Spirometer Sensor streamlines experiments by providing students with real-time data, interactive graphs, and intuitive analysis tools right on their devices. The disposable mouthpieces are designed for use with a single student and feature exchangeable filters that protect the sensor from particulates for maximum safety. Additional mouthpieces are available in convenient packs of ten.

### Features:

- Bi-directional air flow (inspiration and expiration)
- Minimal resistance to air flow
- Displays volume in liters
- Exchangeable filter and disposable, hygienic mouthpieces

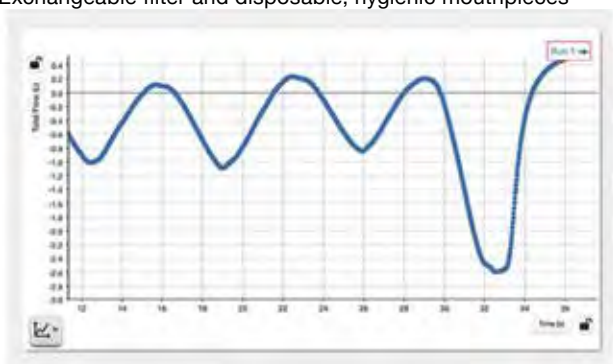

## Wireless EKG Sensor

PS-3236

The Wireless EKG Sensor measures electrical signals produced by contractions of the heart or muscles, and reports them in real-time on virtually any student device. The perfect sensor for fast-paced physiology courses, the EKG Sensor provides students with real-time feedback as they explore the effects of various stimuli on cardiac or muscular activity. Heart Rate data is reported in beats per minute (BPM), while the voltage (mV) detected from cardiac contractions is intuitively displayed in an EKG trace.

### Features:

- Standard three-electrode design
- Easy-to-use, disposable stick-on electrodes
- No messy gel required
- Great for stimulus response reflex studies

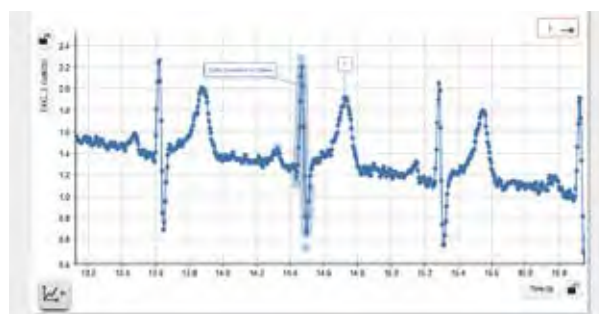

### Order Information

Wireless Spirometer.....	PS-3234
Spirometer Mouthpiece Replacements (10).....	PS-2522
Spirometer Mouthpieces & Pre-Filters.....	PS-3245

### Order Information

Wireless EKG Sensor.....	PS-3236
--------------------------	---------

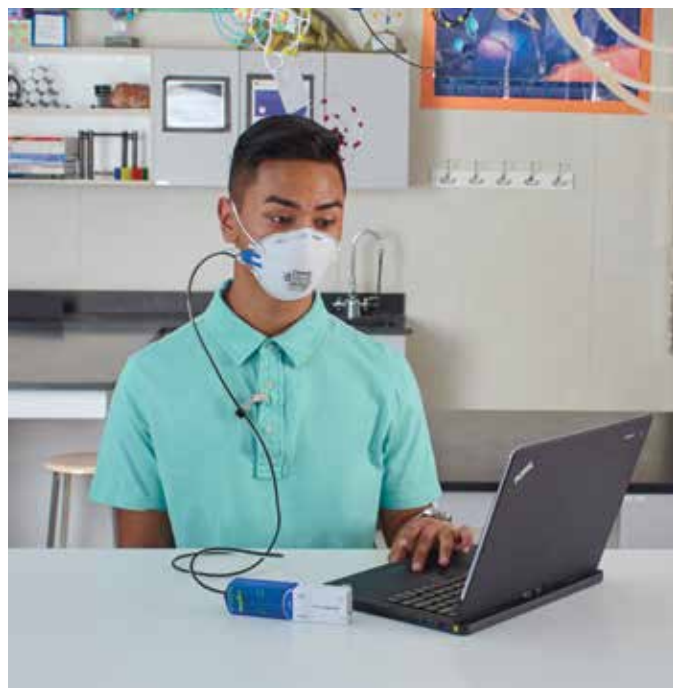

### Go Wireless with PASPORT Sensors

PASCO's AirLink Interface connects PASPORT (blue) sensors to your computer using Bluetooth or USB technology.



### AirLink Interface

PS-3200

The AirLink connects PASPORT sensors to a Mac or Windows computer, Chromebook, iPad, tablet, or smartphone via Bluetooth or USB connection. The USB cable is included.



Order Information	
AirLink Interface .....	PS-3200



### Human Eye Model

OS-8477A

The Human Eye Model makes it easy for students to explore the physiology behind human sight through hands-on manipulation. Investigate normal vision, far-sightedness, and more!

**Features:**

- **Working Model of the Human Eye:** Two lenses are used to form images on the retina. Sealed tank holds water to simulate the vitreous humor. Size and orientation of the illuminated object can be easily measured.
- **Study the Optics of Normal Vision and Vision Correction:** Use the included plastic lenses to create images for normal vision, far-sightedness, near-sightedness, and astigmatism. Additional lenses are placed in front of the eye to correct for vision problems.
- **Fixed Corneal Lens and Interchangeable Crystalline Lens:** The crystalline lens is surrounded by water (vitreous humor). By changing the crystalline lens, the eye can focus on both near and far objects.
- **Movable Retina:** Three positions demonstrate near-sightedness, far-sightedness, and normal vision.
- **Variable Pupil Size:** Students can observe changes in image brightness and clarity as the pupil size is reduced.



*Includes molded plastic eyeball, plastic lenses (two sets of 6), pupil aperture, adjustable focal lens, retina screen, optics caliper (1), syringe, and experiment manual.*

Order Information	
Human Eye Model.....	OS-8477A

## Standard Compound Optical Microscope

SE-6213

Standard optical microscope great for general viewing of cell structures at 40x, 100x, 400x viewing. Gives insights to topics from Biology, Life Science, Anatomy and Physiology, Cellular and Field Biology. High quality optical lenses allow for fine details in high contrast can be studied in appropriate detail for starter to experienced microscope users. Perfect for establishing labs with sets of durable equipment classes can use for years. Compatible with student or



professionally prepared slide set like the Microscope Slide Kingdom survey (SE-6214) gives students a solid start to explore cellular features and concepts across all living kingdoms.

### Features:

- Observe small specimens like plant, animal, and bacterial cells, translucent objects such as insect larvae, or fine particles like powder
- 10 x eye piece
- 10x eyepiece and 4x, 10x, and 40x (oil) objective lenses provide magnification options of 40x, 100x, and 400x
- Adjustable focus between coarse and fine settings
- Dual light source (upper and lower LED) provides adjustable brightness
- Cord or cordless power options (External AC/DC Adaptor or 3xAA Batteries)
- Equipped with a plain stage with clip and single lens condenser with disc diaphragm

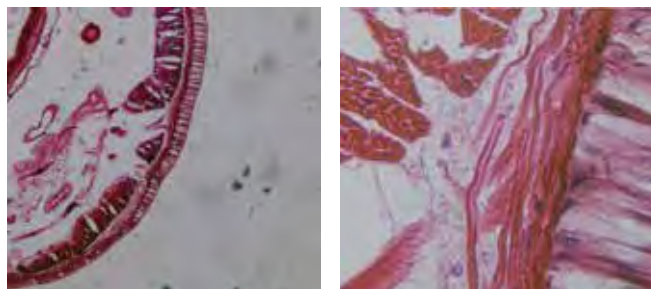

Sample imagery above captured with standard eyepiece USB camera. Slides from the Kingdoms Survey, Prepared Slide Set (sold separately)

### Order Information

Standard Compound Optical Microscope.....SE-6213  
 Prepared Slide Set, Kingdoms Survey .....SE-6214

## Monocular Digital Microscope (40-1000x)

SE-6201

This compound microscope and digital camera combination includes a 100x oil immersion lens, 1.25 N.A. Abbe condenser, and a rechargeable LED illumination system. Motic Images software included. Use with Windows 7 and above. Mac OSX Compatible.



*Note: See online for other microscope options including a Tri-Power Stereo Microscope (10X/20X/40X) and a monocular Microscope (40-1000x) with a detachable 8" LCD tablet that can transmit live images to devices.*

### Order Information

Monocular Digital Microscope (40-1000x).....SE-6201

## USB 3.0 Microscope Camera

SE-6204

This high-resolution camera permits you to use your own microscope to create still or moving microscope images on your PC. With the included Motic Images Plus software, you can view, enhance, label, measure, print, and store the images all with one program. This lightweight digital camera mounts over almost any microscope eyepiece (stereo or compound) with the supplied C-ring adapter and microscope eyepiece adapters. Provides 3.0 megapixels at 2048x1536 framed resolution, everything included for easy plug-and-play, for use with Windows 7 and above and OSX.



*Moticam X3 (SE-6205) streaming high resolution WiFi camera also available. See the PASCO website for more details.*

### Order Information

USB 3.0 Microscope Camera .....SE-6204  
 WiFi Microscope Camera .....SE-6205

## USB Camera Microscope

PS-2343

The versatile USB Camera Microscope is ideal for a variety of applications in the science classroom. Its dual functionality means it can take pictures just like a digital camera, but it can also magnify like a microscope when it's up close to a specimen.

### Features:

- Built-in LED lights
- Optical zoom from 1x to 60x
- Can be used as a webcam



### Order Information

USB Camera Microscope .....PS-2343



## Chemistry Educational solutions for General, AP<sup>®</sup>, IB<sup>®</sup>, and Honors Chemistry courses

### Award-Winning Solutions for Your Chemistry Lab

PASCO provides chemistry educators with the most complete and innovative classroom solutions on the market. Our goal is to provide teachers with affordable, turnkey STEM solutions that combine versatile sensor technology with interactive, NGSS-based curriculum. Using SPARKvue<sup>®</sup> software and our wireless sensors, students can see data collection in real time and perform analyses on their own devices. Plus, our *Essential Chemistry* textbook and interactive e-book make it easy to reinforce student engagement at home and in the classroom.

### Chemistry Index

Chemistry Lab Stations .....	53, 57
Essential Chemistry Curriculum .....	54-55
Advanced Chemistry Solutions.....	56-57
pH & Wireless Drop Counter .....	60-61
Temperature & Heat Stirrer .....	62
Ideal Gas Law & Absolute Zero Sphere .....	63
Pressure & Conductivity .....	64
Electrochemistry with Voltage & Current .....	65
Molecular Model and Geiger Counter .....	66
Polarimeter, Polarizer Demonstrator .....	67
Wireless Colorimeter & Turbidity .....	68
Wireless Spectrometer .....	69
UV-Vis Spectrometer & Comparison Guide .....	70-71
Melt Point Apparatus and Lab Supplies.....	72-73

World Class Support and Professional Development - Committed to Your Success!

# Chemistry Starter Lab Station

EC-6362

The Chemistry Starter Lab Station makes it easy and affordable to begin using sensor-based technology in your chemistry lab or classroom. Inside the Starter Lab Station are the wireless sensors used to perform lab activities from the Essential Chemistry Student Lab Manual. Available separately is the Chemistry Extension Lab Station (EC-6363) which, when combined with the Starter Lab Station, comprises all the wireless sensors students need to perform most of the labs inside the Essential Chemistry Student Lab Manual, plus many of the lab activities found in our Advanced Chemistry Through Inquiry Teacher Guide.



### Chemistry Station Lab Titles

The Chemistry Starter Lab Station supports 7 of the 10 included labs. Add the Extension Lab Station\* to do all 10 lab titles + over 50 more investigations from the Essential Chemistry Lab Manual.

#### 1. Physical or Chemical Change

#### 2. Specific Heat

#### 3. Chemical Reactions

#### 4. Determining Limiting Reactions

#### 5. Types of Bonding\*

#### 6. Evaporative Cooling

#### 7. Solution Concentration\*

#### 8. What is pH

#### 9. Investigation of Acid-Base Titration

#### 10. Lemon Battery\*

The Chemistry Starter & Extension Lab Stations include these wireless sensors and materials:

#### Starter

- Temperature
- Pressure
- pH
- Molecular Models
- Periodic Table
- Periodic Trend Cards
- Spectrum Cards
- Storage Case

#### Extension

- Drop Counter
- Colorimeter & Turbidity
- Conductivity
- Voltage
- Condenser
- Electrode Support



Chemistry Starter (left) & Extension Lab Stations (right)

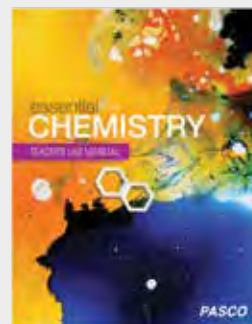

## Essential Chemistry Teacher Lab Manual

EC-6330

The Essential Chemistry Teacher Lab Manual is a complete set of teacher answer keys for the 73 labs inside the Essential Chemistry Student Lab Manual (the printed student lab manual is sold separately). Each teacher key provides sample data, graphs, tables, and correct or sample responses to the analysis questions within each of the 73 student lab investigations. Below is a partial list of labs from the Essential Chemistry Lab Manual:

- Experimental Variables
- Density of a Liquid
- Physical or Chemical Change
- Specific Heat
- Naming Ionic Compounds
- Molar Mass
- Percent Composition of a Hydrate
- Empirical Formula of Magnesium Oxide
- Chemical Reactions
- Solubility Rules
- Determining Limiting Reactants
- Flame Tests
- Lewis Structures and VSEPR
- Evaporative Cooling
- Hess's Law
- Boyle's Law
- Charles' Law
- Solution Concentration
- Catalysts
- Le Châtelier's Principle
- Titration of an Unknown Acid
- Electrochemical Cells
- Electroplating
- Bonding and Organic Chemistry
- + 49 more labs available.

### Order Information

Chemistry Starter Lab Station .....EC-6362  
Essential Chemistry Extension Lab Kit.....EC-6363  
Essential Chemistry Teacher Lab Manual .....EC-6330

# Your Complete Chemistry Solution

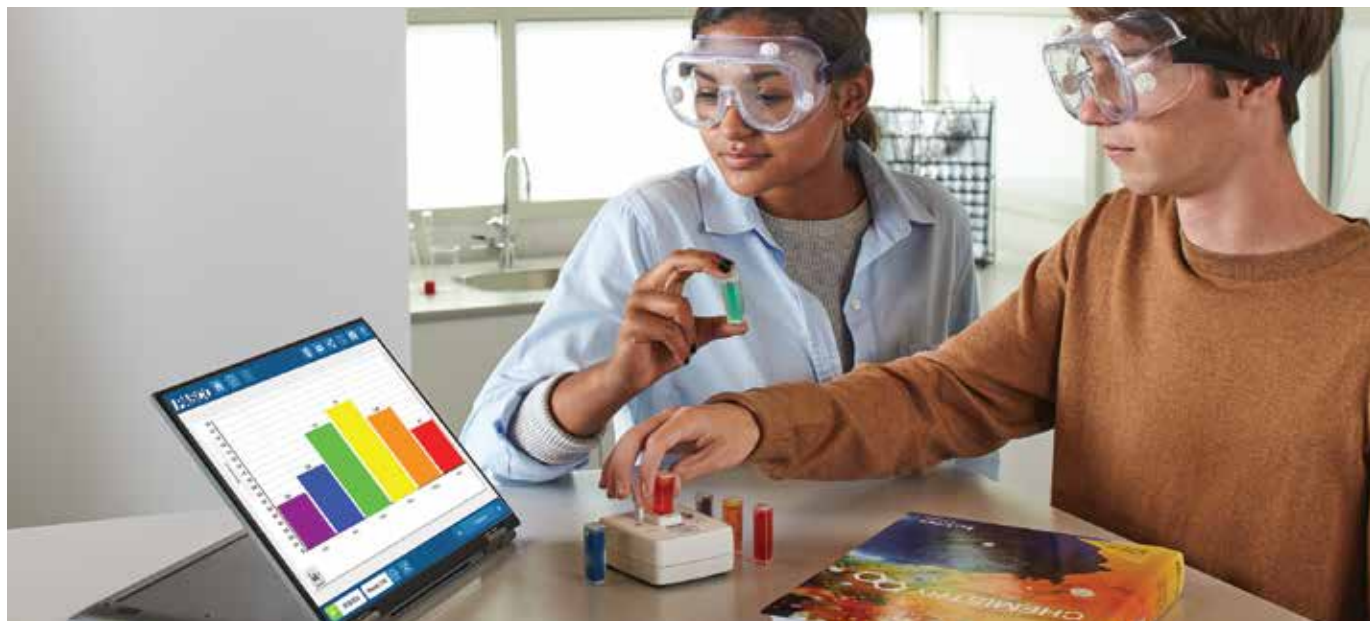

**PASCO's Essential Chemistry** curriculum is the only curriculum solution that includes a Student Textbook, Student e-Book, Teacher e-Resources, Student Lab Manual, Teacher Lab e-Resources, and Equipment Kits, all at a very affordable price. This 3-D STEM program includes a full year of instruction for both General and

Honors Chemistry classes. Use our complete solution or integrate Essential Chemistry into your existing curriculum. Essential Chemistry is multiplatform and works on iOS, Android™, Chrome™, Windows®, and Mac®. What's more, it includes 24/7 online access, as well as correlations to NGSS and your state standards.

## Student Textbook & Lab Manual

- 24 chapters cover a full year of instruction for General and Honors Chemistry
- One main idea per page
- Quality illustrations
- Section and Chapter Reviews
- 73 complete investigations
- 4 Design Projects

## Student e-Book

- Browser-based version of the textbook
- Same layout with convenient 24/7 online access
- Embedded videos and animations bring content to life
- Interactive equations and simulations enrich key concepts
- Formative and summative assessment questions

## Teacher e-Resources for Lab Manual

- Editable documents
- SPARKvue Software
- PowerPoint presentations
- Answer keys
- Video lab assistance

## Teacher e-Resources for Textbook

- Infinite Test Bank
- Teacher User Guide
- Teacher e-Book (1-year or multi-year license)
- Alignment details for NGSS and state standards

## PASCO Academy Chemistry Resources

- Available through your PASCO Educator account
- 25 engaging video labs with detailed instruction and data collection
- 25 datasets for student analysis and discussion
- 25 editable lab handouts with teacher answer keys
- Digital access to more than 70 labs for General and Honors Chemistry

## Equipment

- Standard Equipment Kit supports 47 labs
- Extend your investigations with additional sensors and apparatus

## Essential Chemistry correlates with NGSS and is constructed around the three dimensions:

- Science and Engineering Practices
- Crosscutting Concepts
- Disciplinary Core Ideas





# Textbook + e-Book + Equipment

## Essential Chemistry Student Textbook

EC-6350

This rigorous yet accessible textbook includes core Chemistry topics that cover a complete year of instruction. The lessons follow the 5E model and include tools for ELL students, as well as tools for students with different learning styles. Fully aligned with both general and advanced coursework, this accessible textbook features one main idea per page, quality illustrations, 73 complete investigations, four Engineering Design Projects, and Section and Chapter Reviews. The 24 chapters cover these topics:

- The Science of Chemistry
- Measurement and Analysis
- Classifying Matter
- Temperature and Heat
- Chemical Compounds
- Moles
- Chemical Reactions
- Stoichiometry
- Atomic Structure
- Bonding and Valence
- Energy and Change
- Gases
- Solutions
- Reaction Rates
- Equilibrium
- Acids and Bases
- Oxidation and Reduction
- Electrochemistry
- Nuclear Chemistry
- Organic Chemistry
- Molecular Biology
- Biochemistry
- The Earth
- The Universe

## Essential Chemistry Student e-Book

EC-6350-EB5 (5-yr lic) or EC-6350-EB1 (1-yr lic)

The e-Book is an electronic version of the full textbook plus interactive elements. Throughout the electronic text, content and theory are supported with optional audio reading, as well as interactive elements such as interactive equations, videos, animations, and simulations. Students may also expand content using the 'more' button to go deeper into concepts.

## Essential Chemistry Student Lab Manual

EC-6352

The *Essential Chemistry* Student Lab Manual is a student-consumable print book. In the manual there are 73 labs that cover a full year of instruction. Best of all, the labs are completely integrated with PASCO equipment and software.

## Essential Chemistry Lab Station Equipment Kits

EC-6362 & EC-6363

These equipment kits will outfit a single chemistry lab station of 2-5 students. When used in conjunction with the *Essential Chemistry* program, including the e-Book and lab manual, they create a complete solution for teaching high school chemistry. The equipment kits can also be used to supplement your existing textbook, serving as the lab components of your curriculum. This use is supported by the more than 70 standards-based *Essential Chemistry* labs that are available for free download in the PASCO Experiment Library.



## Essential Chemistry Lab Station Equipment

42 labs are designed to use this equipment set.

- Includes 1 of each of the following:
- Wireless Temperature Sensor PS-3201
  - Wireless pH Sensor PS-3204
  - Wireless Conductivity Sensor PS-3210
  - Wireless Pressure Sensor PS-3203
  - Wireless Voltage Sensor PS-3211
  - Wireless Colorimeter and Turbidity PS-3215
  - Molecular Model Kit PS-3400
  - Electrode Support PS-3505
  - Periodic Trend Cards EC-3405
  - Periodic Table EC-3404
  - Spectrum Cards EC-3403
  - Condenser PS-3402
  - Wireless Drop Counter PS-3214
  - Gratnells® Storage Trays (2)

\*The equipment list (above) includes everything in the *Chemistry Starter and Extension Lab Stations* (EC-6362 + EC-6363).

### Order Information

*Essential Chemistry* 1st Edition: Student Textbook..... EC-6350A  
*Essential Chemistry* 1st Edition: Student e-Book (1 yr license).. EC-6350-EB1  
*Essential Chemistry* Student Lab Manual ..... EC-6352  
*Essential Chemistry* Teacher Lab Manual ..... EC-6330

*Essential Chemistry* Lab Investigations - Teacher Res ..... EC-6353-DIG  
*Essential Chemistry* Starter Lab Station..... EC-6362  
*Essential Chemistry* Extension Lab Kit ..... EC-6363

# Advanced Chemistry Through Inquiry Labs for AP<sup>®</sup> & IB<sup>®</sup>

PASCO's Advanced Chemistry through Inquiry Teacher Guide is newly revised and contains 16 labs that have been specifically designed to support student inquiry, as well as AP<sup>®</sup> and IB<sup>®</sup> curriculum\*. This manual is available in both a print version and an all-digital version.

- Most labs can be completed in one lab session with readily available materials, including the sensor bundles on the opposite page.
- The flexible format provides guided inquiry opportunities and scaffolding, so students can create their own experiments.
- Easy and meaningful data collection leads to increased time for data analysis and open inquiry.
- Labs integrate high-order analysis and synthesis questions.
- Includes sample data for investigations and inquiry, answers to analysis and synthesis questions, an assessment rubric, teacher tips, lab preparation information, and more.

*Initial Investigation* includes step-by-step procedure, questions, and analysis.

*Advanced Investigation* presents a higher level experiment that expands on concepts from the Initial Investigation.

*Extended Inquiry* includes student inquiry and experimental design questions with sample answers.

Advanced Chemistry Lab Experiments	Starter Bundle (PS-3302)	Starter and Extension Bundles (PS-3302, PS-3303C)	IB <sup>®</sup> Standards*	Targeted AP <sup>®</sup> Learning Objectives*
1. Analysis of Food Dyes in Sports Drinks		●	1.5; A.8	SAP-8.A; SAP-8.C
2. Investigating the Copper Content of Brass		●	1.2; 1.5; A.8	SAP-8.C; SPQ-4.A
3. How Hard is Your Tap Water?	●	●	1.4	SPQ-1.A; SPQ-2.A; TRA-1.C; SPQ-3.C; SPQ-4.A
4. How Much Acid is in Your Fruit Juice?	●	●	18.1; 18.4	SPQ-4.B; SPQ-4.A
5. Separating Food Dyes Using Chromatography		●	4.3	SPQ-3.B; SPQ-3.C; SPQ-5.A
6. A Chemistry Mystery: Name That Unknown	●	●	4.3; 4.5	SAP-3.A; SAP-5.B; SAP-3.D
7. Stoichiometry in Solutions	●	●	1.5	SPQ-3.A; SPQ-4.A; SPQ-4.B; SPQ-2.A; SAP-5.B
8. Percentage of H <sub>2</sub> O <sub>2</sub> in Your Drugstore Hydrogen Peroxide		●	9.1; 9.2; 19.1	TRA-1.B; SPQ-4.A; SPQ-4.B
9. Investigating Physical and Chemical Changes of Matter	●	●	4.5	TRA-1.D; TRA-1.C; SAP-5.B
10. What Does Acid Rain Do To Coral Reefs?	●	●	6.1; A.8	TRA-3.A; TRA-3.C
11. Kinetics of Crystal Violet Fading		●	6.1; 16.1; 16.3	TRA-3.B; TRA-3.C; TRA-3.A
12. Building a Better Hand Warmer	●	●	5.1; 5.2; 5.3; 15.1	ENE-2.D; ENE-2.E; ENE-2.F
13. Applications of Le Châtelier's Principle	●	●	7.1; 7.2; 17.2; A.8	TRA-8.A; TRA-8.B
14. Investigation of Acid-Base Titrations	●	●	18.1; 18.4	SAP-9.E; TRA-1.B; SPQ-4.B; TRA-8.A
15. Introduction to Buffers	●	●**	18.2	SAP-10.B; TRA-1.C; SPQ-4.B; SAP-5.B
16. Evaluation of Lemonade as a Buffer	●	●**	18.2	SAP-10.D; SPQ-1.A

\* AP is a registered trademark of the College Board, which was not involved in the production of, and does not endorse, this product. IB is a registered trademark of the International Baccalaureate Organization, which was not involved in the production of, and does not endorse, this product.

\*\* The ORP Probe requires a pH sensor.

## Order Information

Advanced Chemistry Through Inquiry.....PS-2828A

*Includes lab prep instructions, expected answers/results, and editable student files. Manual is available in eco-friendly digital format or in print.*

## Lab Stations Support Advanced Chemistry

The Chemistry Starter Lab Station and Extension Station, together with PASCO's *Advanced Chemistry Through Inquiry Lab Manual*, offer a truly complete solution. With over 15 sensor-based labs covering a range of advanced chemistry topics, and all of the equipment and apparatus required to conduct the labs, hands-on inquiry with data collection and analysis has never been easier or more affordable. Add the Wireless Spectrometer and Oxidation Reduction Potential Probe to your Lab Stations to explore more IB® and AP® investigations.



The Chemistry Starter & Extension Lab Stations include these wireless sensors and materials:

### Starter

- Temperature
- Pressure
- pH
- Molecular Model Kit
- Periodic Table
- Periodic Trend cards
- Spectrum Cards
- Storage Case

### Extension

- Drop Counter
- Colorimeter & Turbidity
- Conductivity
- Voltage
- Condenser
- Electrode Support



## PASPORT Ethanol Sensor

PS-2194

The PASPORT Ethanol Sensor measures the concentration of gaseous ethanol up to 3%. In biology and environmental science labs, students can learn about anaerobic respiration by measuring the production of ethanol by bacterial or yeast fermentation. Physics and chemistry students can begin to explore combustion and thermodynamics. Connect your students to the study of respiration and alternative energy sources with the PASPORT Ethanol Sensor.



Note: This sensor requires an interface for use. Compatible interfaces include the 550 Universal Interface, 850 Universal Interface, AirLink, and SPARKlink Air. See website for full details.

## Oxidation Reduction Potential Probe

PS-3515

This probe connects to the Wireless pH Sensor and allows students to determine the capacity of a chemical species to act as an oxidizing or reducing agent during redox reactions.

Use this probe to monitor solutions during oxidation-reduction titrations, perform water quality studies, and study the effects of water chlorination. This probe is not a standalone sensor. It connects to and requires an amplifier.



### Order Information

Essential Chemistry Starter Lab Kit .....EC-6362  
Essential Chemistry Extension Lab Kit.....EC-6363

PASPORT Ethanol Sensor .....PS-2194  
Oxidation Reduction Potential Probe.....PS-3515



## Wireless pH Sensor

PS-3204

The Wireless pH Sensor is a must-have for any chemistry, biology, or environmental science course. Equally capable in the lab or field, the sensor eliminates the hassle of cables, reducing spills and improving safety. Plus, it rarely requires charging; the sensor's coin cell battery lasts for 2-3 years in most labs and costs about one dollar to replace. It can transmit data in real time, or store data for days when continuous monitoring is required. The Wireless pH Sensor enhances countless activities, including acid-base titrations, investigations into household chemicals, analyses of chemical reactions, water quality studies, and much more.

### Features:

- Simply pair and go, no cables or interfaces to manage
- Compatible with ion-selective electrodes (ISE) and the oxidation reduction probe (ORP)
- Features Bluetooth® wireless connectivity and a long-lasting coin cell battery
- Logs pH data directly onto the sensor for long-term experiments
- Streams live data to SPARKvue and PASCO Capstone for instant visualization and analysis.



Collect measurements, compare pH levels of various solutions, and display data as a graph, digits display, table, and/or histogram.



### Order Information

Wireless pH Sensor.....PS-3204

Wireless pH Sensor Pack .....PS-3331

**Note:** Price for multi-sensor packs includes 8 sensors and custom storage case.



## Wireless Drop Counter

PS-3214

The Wireless Drop Counter has a wide (18 x 13 mm) drop window for better drop detection and easier alignment with burettes. It works equally well with large or small, fast or slow drops.

Measures up to 40 drops per second with drops as small as 0.5 mm.

### Teaching Advantage:

- IR filter assures accurate counts because room lighting cannot affect results
- Sensor unit can suspend two other probes in solution, simplifying many experiments
- Wide drop window (18x13 mm) means better drop detection and easier alignment with burettes

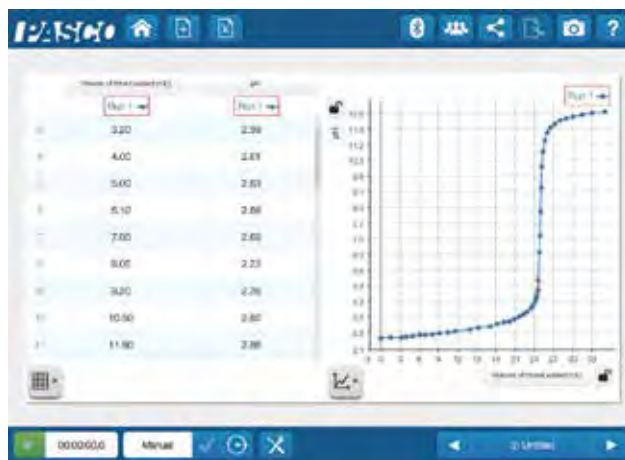

*Includes: Wireless Drop Counter, Stopcock Valves (2), 60 cc Drop Dispenser Syringe with Tip, and Syringe Holder. Included but not shown: Micro Stir Bar and Micro USB Cable (1 m).*

### Order Information

Wireless Drop Counter .....PS-3214



## Wireless Temperature Sensor

PS-3201

Welcome to the modern thermometer. The Wireless Temperature Sensor transmits live data and allows students to continuously monitor, log, and plot temperature measurements on nearly any device. When lab-time ends but the experiment continues, students can set the sensor to log data autonomously for days, weeks, or months, then download it for analysis later. This durable, wireless sensor features a stainless steel probe for the most demanding of applications, as well as a battery that lasts over a year\*. It can be used in a wide array of experiments and activities because it measures small, but significant temperature changes produced by chemical reactions, convection currents, and even skin temperatures.

### Features:

- Simply pair and go, no cables or adapters to manage
- Variable sampling rate for capturing small, fast changes or experiments that run for hours, days, or weeks
- Bluetooth® connectivity and long-lasting coin cell battery
- Logs temperature data directly onto the sensor for long-term experiments
- Dust, dirt, and sand-proof and water resistant (IP-X7 certified)

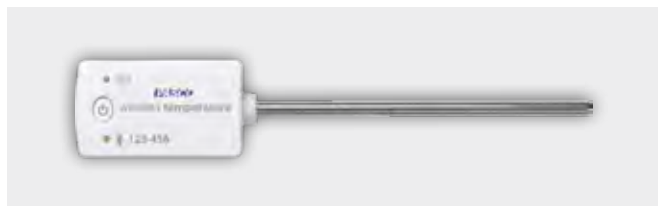

### Order Information

Wireless Temperature Sensor.....PS-3201

Wireless Temperature Sensor Pack.....PS-3330

**Note:** Price for multi-sensor packs includes 8 sensors and custom storage case.

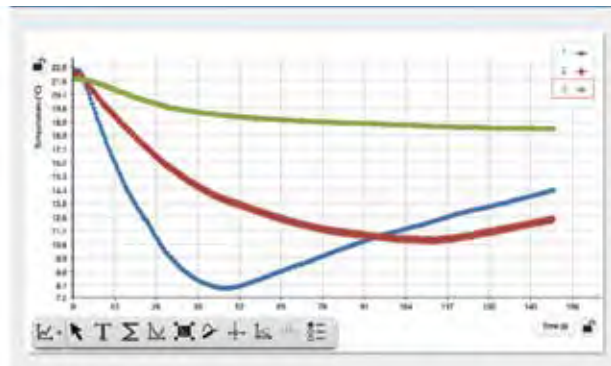

Heats of evaporation indicate strength of intermolecular motion.

## Heater Stirrer

PS-3401

This compact hot plate and stirrer has a white ceramic top that is ideal for heating and for seeing color changes when mixing solutions. It has been designed to withstand spills. Its safety features include warning labels and indicator LEDs. And the included rod makes it easy to support sensors.



### Order Information

Heater Stirrer.....PS-3401

## OHAUS Scout SKX Balance 220g

SE-8823A

The Ohaus Scout SKX digital electronic balances combine range, resolution, and low cost, making them ideal for use in teaching labs.

Simple two-button operation and visual menu prompts allow students to begin weighing with minimal instruction. The large, crisp display is easily viewed from any angle, so teachers can quickly check student results. A sealed front panel, molded spill ring, and removable stainless steel platforms provide protection from spills and make these balances easy to keep clean.

Use Ohaus SKX series electronic balances in conjunction with SPARKvue or PASCO Capstone software. Connect any SKX balance to a computer via USB.



### Order Information

OHAUS Scout SKX Balance 220g.....SE-8823A

Ohaus USB Adapter.....SE-8821

## Wireless Temperature Sensor Link



PS-3222

The Wireless Temperature Sensor Link enables wireless connection for any PASCO temperature probe with a 3.5 mm connection. The link comes with a Fast Response Temperature Probe, but it can also connect to the Stainless Steel Temperature Probe, Skin/Surface Temperature Probe, the Absolute Zero Sphere, and the Ideal Gas Law Apparatus.



### Order Information

Wireless Temperature Sensor Link.....PS-3222



## Absolute Zero Sphere

TD-8595

The Absolute Zero Sphere is an effective tool for determining absolute zero temperature. Students connect Pressure and Temperature Sensors before immersing the sphere in water baths of varying temperatures. As the pressure and temperature change, a live graph is generated in PASCO Capstone™. Once the data is collected, students can use a linear fit to extrapolate the value of absolute zero.

## Ideal Gas Law Apparatus

TD-8596A

Investigating the Ideal Gas Law is simple using PASCO's Ideal Gas Law Apparatus. By connecting a Pressure Sensor and a Temperature Sensor to the syringe, students can quantitatively look at the relationships between pressure, temperature, and volume.



*Includes Ideal Gas Law Syringe, built-in fast response thermistor, with male leuc connector. A Wireless Pressure Sensor (PS-3203) and Wireless Temperature Link (PS-3222) are required for data collection.*



Absolute Zero Sphere Connector

*Includes built-in fast response thermistor, with male leuc connector. For data collection a Wireless Pressure Sensor (PS-3203) and Wireless Temperature Link (PS-3222) are required.*

### Order Information

Ideal Gas Law Apparatus .....TD-8596A

### Order Information

Absolute Zero Sphere.....TD-8595



## Wireless Pressure Sensor

PS-3203

The Wireless Pressure Sensor allows students to easily collect accurate gas pressure data for a wide range of applications. Included is a 60cc syringe, tubing, and connectors that facilitate experiments such as Boyle's Law and measuring pinch-grip strength. Within PASCO's software, students can easily select their desired units from a list containing kPa, mmHg, inHg, mbar, psi, atm, and torr.

### Features:

- Measures pressure even when the pressure within the system drops below ambient pressure
- Supports common units (kPa, atm, psi, mmHg, or N/m<sup>2</sup>) for many applications
- Bluetooth® wireless connectivity and long-lasting rechargeable battery

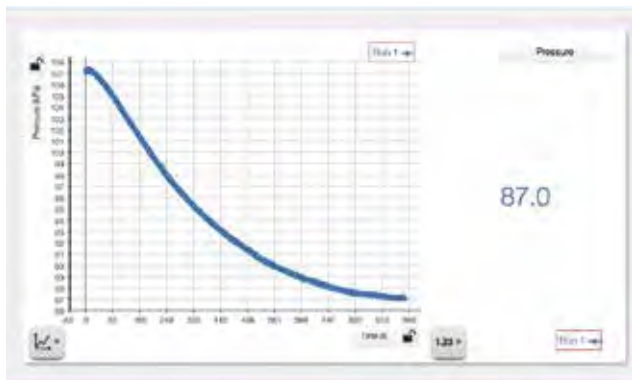

### Order Information

Wireless Pressure Sensor .....PS-3203  
 Wireless Pressure Sensor Pack.....PS-3333

**Note:** Price for multi-sensor packs includes 8 sensors and custom storage case.



## Wireless Conductivity Sensor

PS-3210A

The Wireless Conductivity Sensor measures the electrical conductivity of an aqueous solution. It is ideal for investigating the properties of solutions, including total dissolved solids (TDS) for water quality inquiry. Because it is temperature compensated, calibrations are less frequent and can be applied across a range of temperatures. With an improved range of 0 to 40,000  $\mu\text{S}/\text{cm}$ , this sensor can be utilized for chemical, biological, and environmental studies.

Teacher tip: To measure brackish or marine samples, perform a dilution until the measurement falls within the range, then multiply to determine sample conductivity.

### Features:

- Measure conductivity and total dissolved solids
- Automatic temperature compensation
- Battery life >1 year
- Remote logging with built-in memory
- Dust-proof, sand-proof, and water-resistant (1 meter for 30 minutes)



### Order Information

Wireless Conductivity Sensor .....PS-3210A  
 Wireless Conductivity Sensor Pack.....PS-3332

**Note:** Price for multi-sensor packs includes 8 sensors and custom storage case.





## Wireless Voltage Sensor

PS-3211

The Wireless Voltage Sensor helps chemistry students investigate redox reactions, electrolytic cell potentials, and the impact solution strength on these generated potentials. By testing potential differences between two half reactions, separated by a salt bridge, students can begin to understand the driving forces behind modern batteries.

### Features:

- **Two Ranges:**  $\pm 15$  V,  $\pm 5$  V
- **Resolution:** 7 mV ( $\pm 15$  V range); 2 mV ( $\pm 5$  V range)
- Bluetooth® sampling rate of 1 kHz
- Higher speed sampling via USB
- Remote logging



### Order Information

Wireless Voltage Sensor .....PS-3211

Wireless Voltage Sensor Pack .....PS-3335

**Note:** Price for multi-sensor packs includes 8 sensors and custom storage case.

## Wireless Current Sensor

PS-3212

Current sensors enable chemistry students to count the electrons involved in driving reactions, much like how a scale accounts for mass in reactions. Amperage determines how many atoms are involved in a chemical reaction. Since the two are related, current can be used to find out how much reactant is available in a solution. Integrating currents keeps track of how much metal might electroplate onto an electrode.

### Features:

- **Two Ranges:**  $\pm 1.0$  A and  $\pm 0.1$  A
- **Resolution:** 0.2 mA at  $\pm 1$  A range and 0.02 mA at  $\pm 0.1$  A range
- Bluetooth® sampling rate of 1.0 kHz
- Higher speed sampling via USB
- Remote logging
- Variable sampling rate for recording small, fast changes or experiments that run for hours, days, or weeks

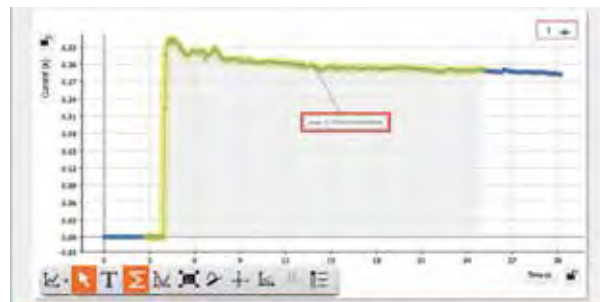

### Order Information

Wireless Current Sensor .....PS-3212

Wireless Current Sensor Pack .....PS-3336

**Note:** Price for multi-sensor packs includes 8 sensors and custom storage case.



## Molecular Model Set

PS-3400

The Molecular Model Set is the perfect tool to help students understand core science concepts such as chemical formulas, equation balancing and the conservation of mass. They are critical to making more advanced concepts easier to visualize and allow students to predict polarity and study reaction mechanisms. Students can explore intermolecular attractions, steric hindrances, nomenclature and complex structure. Anything is possible for students, from creating simple water or carbon dioxide molecules to complex biochemicals such as amino acids and lipids. The set is ideal for studying Chemistry and Biochemistry.



### Order Information

Molecular Model Set.....PS-3400



## Wireless Geiger Counter



PS-3238

The PASCO Wireless Geiger Counter counts beta, gamma and alpha radiation particles as they enter the Geiger–Müller detector tube inside the counter. Designed for easy mounting, the Geiger Counter provides superior position control in inverse square law labs, as well as an audible beep to indicate the detection of ionizing radiation. The front plastic snout fits conveniently inside the NU-3344 Sample Holder stand (available separately), which stabilizes the front of the counter's detector tube exactly 1 cm from the first slot in the holder.

With the Wireless Geiger Counter, students can wirelessly control the high voltage supplied to the Geiger–Müller tube inside the counter, enabling them to make measurements of counts/interval for different tube voltages. They can also plot counts/interval versus tube voltages to experimentally observe the Geiger plateau characteristics of the tube.

### Features:

- Built-in metal mesh screen to protect the delicate mica window in the front of the Geiger–Müller detector tube
- Audible beep count indication that is easily switched on or off
- **Versatile positioning options:** either in the NU-3344 Sample Holder, hand-held, or mounted on a rod stand
- Convenient design to natively fit the PASCO NU-3344 Sample Holder
- Provides wireless control over the high voltage supplied to the Geiger–Müller tube inside the counter for Geiger plateau experiments

### Includes:

- Wireless Geiger Counter
- Micro USB Cable: PS-3584
- Threaded handle for mounting the sensor to a ring stand



### Order Information

Wireless Geiger Counter.....PS-3238

Geiger Counter Sample Holder.....NU-3344



## Wireless Polarimeter

PS-3237

The Wireless Polarimeter has both Bluetooth® and USB connectivity, making it possible to analyze chiral compounds with your iPad®, Chromebook™, Android tablet, or computer. It is ideal for introductory experiments in organic chemistry and biochemistry, where chiral compounds are of special interest.

PASCO's Wireless Polarimeter passes plane polarized light through a vertical sample, which contains a chiral compound, followed by an analyzer and detector. The optical rotation is determined by finding the angle between the starting position and the location where the optimum light level transmits through the cross polarizer. Students can use the rotation data to calculate the concentration of a chiral sample, while the specific rotation (amount turned per g/ml dissolved) is an intrinsic property that can be used to differentiate molecules or determine racemic mixtures.

### Specifications:

- **Connectivity:** Bluetooth and USB
- **LED light source:** 589 nm
- **Optical Rotation Accuracy:**  $\pm 0.09^\circ$
- **Cell Length:** 101.3mm  $\pm$  0.8mm

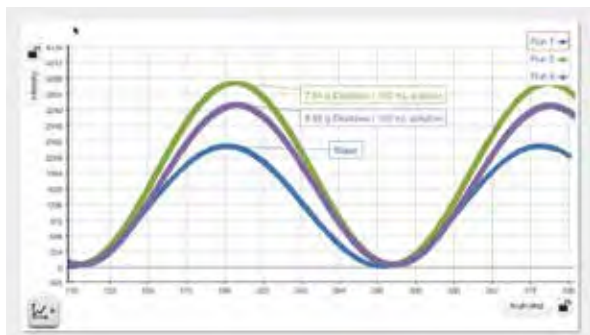

### Order Information

Wireless Polarimeter .....PS-3237

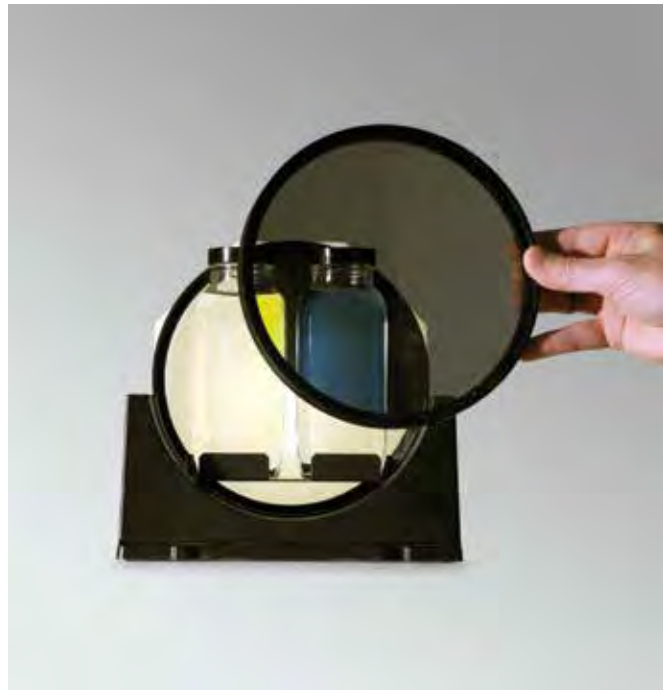

## Polarizer Demonstrator

OS-9477A

Confirm Malus' Law using the Polarizer Demonstrator and a Light Sensor. The angle is read directly from the polarizer, which is marked in 5° increments. Any light source can be used, but the experiment works especially well with the PASCO Color Mixer (OS-8496). See pasco.com for more information.

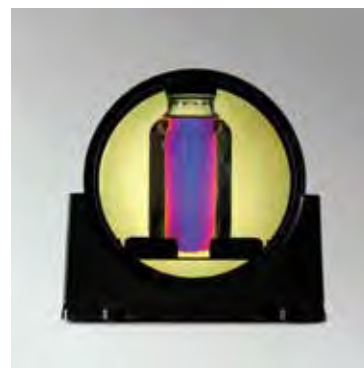

*Introduce the concept of polarization with this colorful and meaningful demonstration.*



### Order Information

Polarizer Demonstrator .....OS-9477A



## Wireless Colorimeter & Turbidity Sensor

PS-3215

The Wireless Colorimeter & Turbidity Sensor simultaneously measures the absorbance and transmittance of six different wavelengths. The sensor can be used to study Beer's Law (absorbance vs. concentration), enzyme activity, photosynthesis, and the rates of chemical reactions (absorbance vs. time). After a simple calibration, students can quickly begin viewing live measurements as they materialize across the visible spectrum at 650 nm (red), 600 nm (orange), 570 nm (yellow), 550 nm (green), 500 nm (blue), and 450 nm (violet).

This sensor also functions as a high-quality turbidimeter for water quality analysis. Rather than simply measuring transmitted light, the Wireless Colorimeter and Turbidity Sensor measures light scattered at a 90 degree angle from the sample, resulting in accurate and repeatable measurements. Additionally, the internal housing for the cuvette is opaque, which limits ambient light interference to preserve accuracy.

### Features:

- Stabilized light source for consistent readings
- Measures six different wavelengths simultaneously
- PASCO software displays the absorbance & transmittance at each wavelength in the appropriate color
- Directly calibrated to read ezSample concentrations of Ammonia, Nitrate, Phosphate, Iron and Chlorine in ppm.
- Functions as both a colorimeter and turbidimeter



Includes: USB charging cable, 9 cuvettes, 2 cuvette racks, and one 100 NTU calibration cuvette.

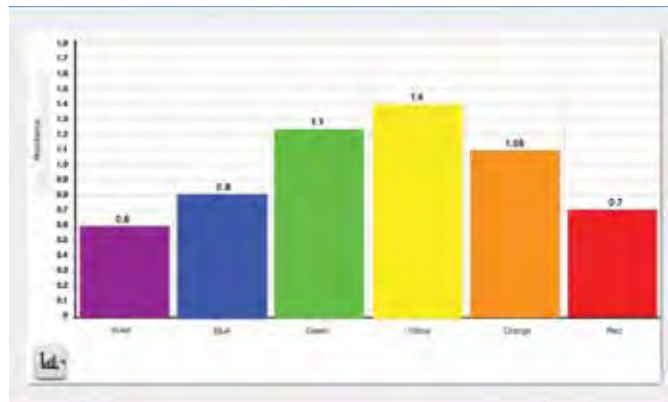
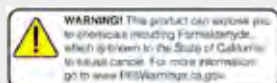

Measure the absorbance and transmittance of a solution at six different wavelengths simultaneously!

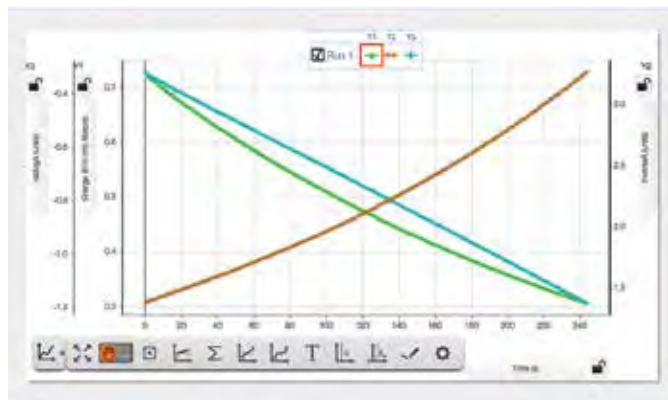

Graphically visualize how a reaction changes over time. Use SPARKvue to visualize multiple measurements on the same graph.

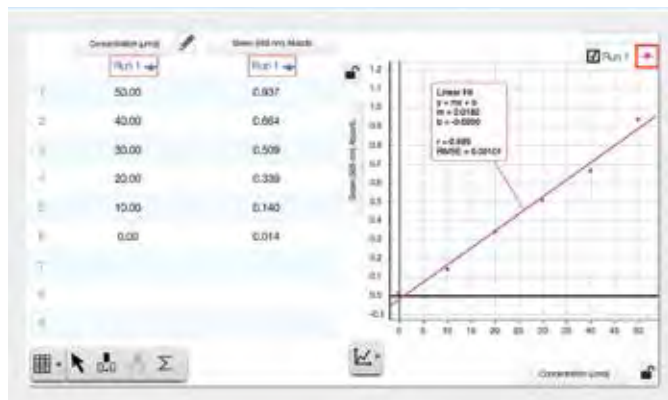

## Cuvettes and Caps

SE-8739

Set of 100 identical 3.5-mL polystyrene cuvettes and caps. Transparent to visible light.



### Order Information

Cuvettes and Caps.....SE-8739

### Order Information

Wireless Colorimeter & Turbidity Sensor.....PS-3215

Wireless Colorimeter & Turbidity Sensor Pack .....PS-3334

**Note:** Price for multi-sensor packs includes 8 sensors and custom storage case.



## Wireless Spectrometer (VIS)

PS-2600A

The award-winning PASCO Wireless Spectrometer is specifically designed for modern chemistry, biology, and physics labs. It connects to student devices via USB or Bluetooth Low Energy and includes free Spectrometry software with built-in tools for spectral analysis. Scan times are fast, enabling students to collect a full spectrum of data in less than a second. Plots are provided for common applications, including Absorbance vs. Wavelength (or Intensity vs. Wavelength), Absorbance vs. Concentration (Beer's law), and Absorbance vs. Time.

### Perform these labs with the PASCO Wireless Spectrometer:

- Emission Spectra of Light
- Absorbance Spectra
- Beer's Law
- Kinetics
- Fluorescence

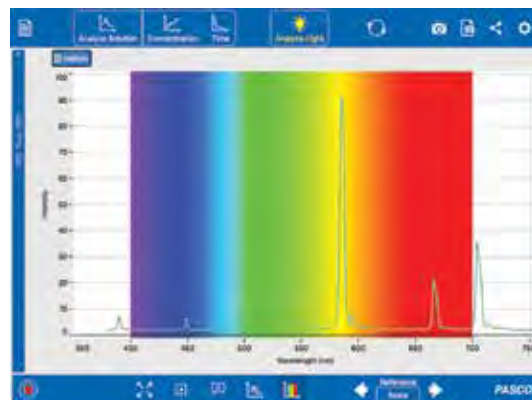

Analyze light sources with the optional Fiber Optic Cable. Easily compare the spectrum to known reference lines in the software.

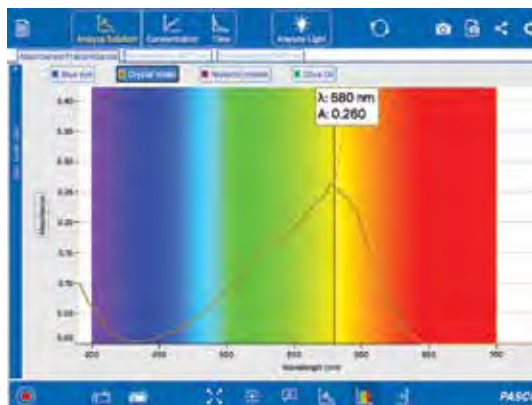

Full visible spectrum includes a large digits display that helps students select wavelengths and determine absorbance values.



**Order Information**

Wireless Spectrometer (Vis) .....PS-2600A  
Includes USB charging cable, 10 cuvettes, and Spectrometry Software.

# Instrument Comparison Guide

Compare features and capabilities to find the right instrument for your lab.



Colorimeter & Turbidity  
PS-3215



Wireless Spectrometer  
PS-2600A



PASCO UV-Vis Spectrometer  
SE-3607

Feature	Colorimeter & Turbidity	Wireless Spectrometer	UV-Vis Spectrometer
Light Source	White LED	RGB LED-Boosted Tungsten	Deuterium (UV) Tungsten (Vis)
Optical Resolution	±25 nm	2 nm	1 nm
Wavelength Range	450, 500, 550, 570, 600, 650 nm	390 – 950 nm	180 – 1050 nm
Wavelength Accuracy	NA	≤6 nm	1 nm
Photometric Range (for best accuracy)	0.05 to 1.5	0.1 to 1.4	0.1 to 1.0
Photometric Accuracy	±5%	±10%	±5%
Full Spectrum Scans	No	Yes	Yes
Scan Time	N/A	1 ms – 25 s	4 ms – 10 s
Connects via USB	Yes	Yes	Yes
Connects via Bluetooth	Yes	Yes	No
Rechargeable battery (for cordless operation only)	Yes	Yes	No
Fluorescent Excitation	No	405, 500 nm	No
Works with SPARKvue & Capstone Software	Yes	No	No
Works with PASCO Spectrometry Software	No	Yes	Yes
Data Storage/Onboard Memory	Yes	No	No
Good for Field Use	Yes	Yes	N/A
Turbidimeter	Yes	No	No



## UV-Vis Spectrometer

SE-3607

The SE-3607 is an easy-to-use, wide range UV-Vis spectrometer that delivers fast, accurate and reliable performance for routine analyses in chemistry and biochemistry teaching labs. With USB connectivity and cross-platform Spectrometry Software, the PASCO UV-Vis Spectrometer improves collaboration between lab members, enabling data collected on a computer or laptop to be analyzed on tablets, iPads, and Chromebooks. Additional accessories, such as the UV-Vis Fiber Optic Kit, can be used to extend the spectrometer's capabilities for the analysis of emission spectra, light sources, and the classification of lasers.

### Highlights:

- Spectral scans from 180 to 1050 nm
- Award-winning Spectrometry software
- One-click light and dark calibrations
- Fast warm-up time (<10 minutes)
- Adjustable scan averaging, signal integration time and smoothing
- Graphs Absorbance vs. Wavelength
- Graphs Intensity vs. Wavelength (emission spectra)
- Graphs Absorbance vs. Concentration (Beer's Law)
- Graphs Absorption vs. Time (kinetics)

### Applications:

- Determination of solution concentrations
- Identification of unknown substances
- Measurement of reaction rates or rate of decay
- Colorimetric assays (e.g., BCA, Bradford, Lowry)
- Purity testing of synthesized compounds
- Determination of the equilibrium constant
- Determination of molar absorption coefficients
- Quality testing (e.g., fermentation mediums, food adulteration, QA levels)

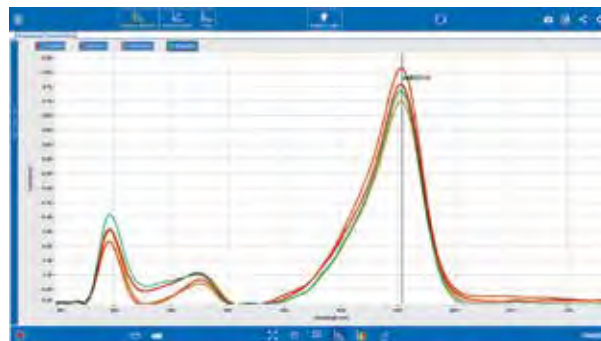

Absorbance of solutions containing various amounts of NaOH.

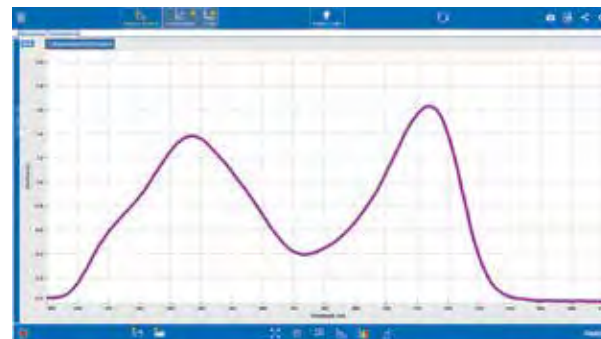

Absorbance of Aspirin.

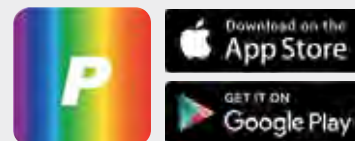
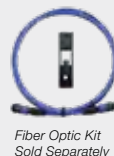

For Mac® and Windows® Computers go to [pasco.com/downloads](http://pasco.com/downloads)

### Order Information

UV-Vis Spectrometer.....SE-3607  
 UV-Vis Fiber Optic Kit.....SE-7182

UV Quartz Cuvettes (Qty. 2) ..... SE-3611  
 Disposable UV Semi-Micro Volume Cuvettes (Qty. 10) .....SE-3610



## Melting Point Apparatus

**NEW**

PS-3239

Melt point range is an important factor for determining the identity and purity of compounds, which is primary focus of many college chemistry labs. The built-in magnifying eyepiece allows students to observe the melting process individually, or a USB camera can be mounted to record the process to view in real time on a screen for larger groups.

The variable ramp rates allow you to quickly raise the sample temperature near melting (to preserve lab time) before slowing the rate down again, and the hold temp command ensures all substances reach a uniform temperature. Check the current temperature easily with the built-in temperature sensor, and use the cooling fan between measurements to restore the heating block to room temperature fast.

## Melting Point Apparatus Eyepiece Camera

SE-6215

Short focal length digital eyepiece camera to capture the melting process. Image stacks will be time coded to compare to temperature data from the Melting Point Apparatus. Images can be scheduled to be captured every 5 seconds during the heating curve for more accurate determination of substances melting points.

### Order Information

Melting Point Apparatus .....PS-3239  
 Melting Point Apparatus Eyepiece Camera .....SE-6215





## pH Buffer Capsule Kit

SC-2321

This set of capsules can be used to create a quick and reliable preparation of fresh solutions of known pH values for calibrating the PASPORT pH Sensor (such as PS-2102 and other pH sensors)

Contains one vial each, with 10 capsules per vial of pH 4.0, pH 7.0, and pH 10.0. Each capsule is sufficient to make 100 mL buffer solution. Includes preservative solution which contains a pH indicator and colors each buffer solution for easy identification.

Using distilled water, the user can formulate clear solutions accurate to  $\pm 0.02$  pH unit. The dry powder remains stable.



Standard buffer capsule kit. pH of 4, 7 and 10.

### Order Information

pH Buffer Capsule Kit.....SC-2321

## Round Base with Rod and Clamps



Round Base with Rod



Right Angle Clamp

Test Tube Clamp

Three-Finger Clamp

### Order Information

Round Base with Rod.....ME-8270  
 Three-Finger Clamp.....SE-9445  
 Right Angle Clamp.....SE-9444  
 Test Tube-Utility Clamp.....SE-9446

## Flat pH Probe

PS-3514

The Flat pH Probe gives you the freedom to measure what you want, where you want. Study pH levels in different kinds of foods, investigate the pH of common skin and hair care products, and easily collect pH data when doing soil analysis. Can be used on semi-solids by pressing the probe against a moist surface. This product is intended for use with the Wireless pH Sensor.



## Oxidation Reduction Potential Probe

PS-3515

This probe connects to the Wireless pH Sensor and measures the potential of a solution to be oxidized or reduced in comparison to a silver/silver chloride reference cell. This allows students to determine the ability of a species in a solution to act as an oxidizing agent or reducing agent during redox reactions.

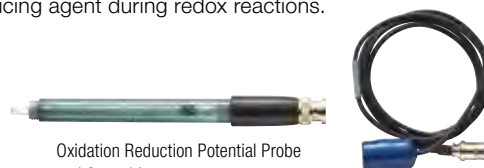

Oxidation Reduction Potential Probe and 2m cable

## Ion Selective Electrodes

PASCO's collection of ISEs all connect to the Wireless pH Sensor and allows students to measure the concentration of various ions in an aqueous solutions. All of the electrodes include a (BNC) extension cable.



Ammonium Ion

Carbon Dioxide Ion

Calcium Ion

Chloride Ion

Potassium Ion

Nitrate Ion

### Order Information

Flat pH Probe.....PS-3514  
 Oxidation Reduction Potential Probe.....PS-3515  
**Ion Selective Electrodes**  
 Ammonium Ion Selective Electrode.....PS-3516  
 Carbon Dioxide Ion Selective Electrode.....PS-3517  
 Calcium Ion Selective Electrode.....PS-3518  
 Chloride Ion Selective Electrode.....PS-3519  
 Potassium Ion Selective Electrode.....PS-3520  
 Nitrate Ion Selective Electrode.....PS-3521

*NOTE: All probes and electrodes (listed above) are designed for use with the Wireless pH Sensor (PS-3204)*



**Environmental Science** Solutions for General, Advanced, and AG courses

**Integrated Solutions for Environmental Science**

Facilitate student investigations of environmental topics anytime, anywhere with PASCO. We offer cutting-edge solutions for both general and advanced environmental science courses, as well as agricultural science courses. Using our award-winning Wireless Sensors and cross-platform software, students can collect and visualize live data, analyze lab results, and log measurements for long-term studies. Pair them with our standards-aligned labs to investigate countless environmental concepts, both inside and outside the classroom.

**Environmental Science Index**

AG Science Starter Lab Station.....73  
 Advanced Environmental Science.....74  
 Lab Stations .....75  
 CO<sub>2</sub>, Soil Moisture.....76  
 Weather with GPS, Weather Vane Accessory .....77  
 Temperature, pH.....78  
 Conductivity, Light .....79  
 Density Model and Dissolved Oxygen Sensor.....80  
 EcoZone System, Greenhouse Kit.....81  
 Water Quality Testing, ezSample Kits..... 82  
 Water Quality and Flow Rate Sensors .....83

**World Class Support and Professional Development - Committed to Your Success!**

We want you to have all the support, guidance, and training you need. Just let us know how we can help.

# AG Science Starter Lab Station

EB-6336

The Agricultural Science Starter Lab Station makes it both easy and affordable to begin using sensor-based technology with your environmental or agricultural science students. Complete with wireless sensors, ten student labs, and a storage case, the Starter Lab Station lets students investigate environmental concepts such as soil quality, water treatment, and the energy content of food. Add the Agricultural Science Extension Lab Station to perform all ten of the included student labs, plus dozens of hands-on activities from the PASCO Experiment Library.



## AG Science Lab Manual

Available online, PASCO's Agricultural Science Lab Manual includes twelve student investigations that cover a variety of environmental topics. Each investigation comes classroom-ready with an editable student lab handout, sample data, and teacher answer key. To download labs and view standards-alignment details, visit the PASCO Experiment Library online.

### AG Science Station Lab Titles

The AG Science Starter Lab Station supports 7 of the 10 labs. Add the Extension Lab Station\* to do all 10 lab titles.

#### Determining Soil Quality

#### Water Treatment

#### Freshwater Quality Monitoring\*

#### Respiration of Germinating Seeds



Shown here: AG Science Starter Lab Station

#### Plant Pigments & Photosynthesis

#### Plant Respiration & Photosynthesis

#### Modeling an Ecosystem\*

#### Greenhouse Gases\*

#### Energy Content of Food

#### Diffusion

The AG Science Starter Lab Station includes a lab manual and these wireless sensors and apparatus:

- Temperature
- pH
- CO<sub>2</sub>
- Conductivity
- Colorimeter & Turbidity
- Storage Case

*\*To do the remaining 3 labs from the AG Science Lab Manual (listed above), add the Extension Lab Station (see page 73). Add the AG Science Teacher Lab Manual to perform an additional 4 AG science labs.*

- Determining Soil Quality
- Water Treatment
- Freshwater Quality Monitoring
- Water and pH
- Respiration of Germinating Seeds
- Plant Pigments and Photosynthesis
- Plant Respiration and Photosynthesis
- Modeling an Ecosystem
- Greenhouse Gases
- Energy Content of Food
- Diffusion
- Soil and pH

### Order Information

Agricultural Science Starter Lab Station .....EB-6336



# Advanced Environmental Science Through Inquiry Labs for AP<sup>®</sup> & IB<sup>®</sup>

PASCO's Advanced Environmental Science Through Inquiry Teacher Lab Manual contains 22 labs that have been specifically designed to support student inquiry, as well as AP<sup>®</sup> and IB<sup>®</sup> curriculum\*. This manual is available in both a print version and an all-digital version.

- Most labs can be completed in one lab session with readily available materials, including the sensor bundles on the opposite page.
- Easy and meaningful data collection leads to increased time for data analysis and open inquiry.
- Includes sample data for investigations and inquiry, answers to analysis and synthesis questions, an assessment rubric, teacher tips, lab preparation information, and more.
- Labs integrate high-order analysis and synthesis questions.
- The flexible format provides guided inquiry opportunities and scaffolding, so students can create their own experiments.

Note: The included labs offer a variety of structured, guided and open inquiry approaches, allowing students to explore both traditional and self-selected environmental concepts.

Advanced Environmental Science Lab Experiments	Starter Bundle (PS-7616B)	Starter and Extension Bundles (PS-7616B, PS-7617C)	IB <sup>®</sup> Standards*	Targeted AP <sup>®</sup> Learning Objectives*
1. Determining Soil Quality		●	5.1; 5.2; 5.3	ERT-4.B; 4.C
2. Insolation and the Seasons	●	●	1.2	ENG-2.A
3. Investigating Specific Heat	●	●	1.2; 2.3	ENG-2.A
4. Monitoring Microclimates	●	●	7.1; 7.2; 7.3	ENG-2.B; ERT-4.E
5. Sunlight Intensity and Reflectivity	●	●	2.3; 7.1-7.3	ENG-2.A
6. Tracking Weather	●	●	7.2; 7.3	ERT-4.E; ENG-2.B
7. Earth's Magnetic Field	●	●	1.2	ERT-4.A
8. Radiation Energy Transfer	●	●	1.2; 2.3	ENG-3.J
9. Seafloor Spreading & Plate Tectonics**	●	●	1.2	ERT-4.A
10. Modeling an Ecosystem		●	1.2; 2.4; 2.5; 3.1	ENT-1.B-1.G; ENG-1.C
11. Photosynthesis and Primary Productivity		●	1.1; 1.2; 2.3; 5.2	ENG-1.A; ERT-1.C; 1.D
12. Photosynthesis and Cell Respiration		●	1.1; 1.2; 2.3; 5.2	ENG-1.B
13. Cellular Respiration and Carbon Cycle		●	1.1; 1.2; 6.1; 6.2	ENG-1.B
14. Energy Content of Food	●	●	1.3; 2.3	ENG-1.B
15. Weather in a Terrarium	●	●	1.1; 1.2; 7.2; 7.3	ERT-4.E
16. Yeast Respiration		●	1.1; 1.2	ENG-3.I
17. Properties of Water	●	●	4.1; 4.2	STB-3.N
18. Air Pollution and Acid Rain	●	●	6.1; 6.2; 6.3; 6.4	STB-2.H
19. Monitoring Water Quality		●	4.1; 4.2; 4.4	STB-3.E
20. Toxicology Using Yeast	●	●	1.1; 1.2	EIN-3.A
21. Water Treatment		●	4.1; 4.2; 4.4	STB-3.N
22. Greenhouse Gases	●	●	6.1; 6.2; 6.3; 6.4	STB-4.E

\* IB is a registered trademark of the International Baccalaureate Organization, which was not involved in the production of, and does not endorse, this product. AP is a trademark registered and/or owned by the College Board, which was not involved in the production of, and does not endorse, this product.

\*\*Requires Wireless 3-Axis Magnetic Field Sensor; see opposite page.

# AG Science Lab Stations Support Advanced Environmental Science Investigations

Together, the Agricultural Starter and Extension Lab Stations offer a lab-ready solution for exploring essential topics in agricultural and environmental science. When paired with PASCO's Advanced Environmental Science Through Inquiry Lab Manual, students can perform more than 20 sensor-based experiments, complete with hands-on data collection, visualization, and analysis. Add the Water Quality Field Guide to extend your investigations even further.



## Water Quality Field Guide

PS-2829A

The Water Quality Field Guide is a combination 'how-to' and 'why?' reference. It covers how to successfully measure water quality in the field, why these measurements are important, and what they mean.

### AG Science Station Lab Titles

Together, the AG Science Starter and Extension Lab Stations support over 20 Advanced Environmental labs. Conduct the 10 labs below right out of the box.

#### 1. Determining Soil Quality

#### 2. Water Treatment

#### 3. Freshwater Quality Monitoring

#### 4. Respiration of Germinating Seeds

#### 5. Plant Pigments & Photosynthesis

#### 6. Plant Respiration & Photosynthesis

#### 7. Modeling an Ecosystem

#### 8. Greenhouse Gases

#### 9. Energy Content of Food

#### 10. Diffusion



## Wireless Magnetic Field Sensor

PS-3221

This 3-Axis Magnetic Field Sensor can sense the Earth's magnetic field, as well as fields from coils and bar magnets. There are two ranges:  $\pm 50$  gauss and  $\pm 1300$  gauss. This sensor is primarily for static fields.



Shown here: AG Science Starter and Extension Lab Stations

The AG Science Starter & Extension Lab Stations include these wireless sensors and materials:

- Temperature
- Conductivity
- pH
- CO<sub>2</sub>
- Colorimeter
- Turbidity
- Optical Dissolved Oxygen
- Weather with GPS
- EcoZone System
- Lab Manual
- Storage Case

### Order Information

Advanced Environmental and Earth Sciences Teacher Guide .....PS-2979  
 Agricultural Science Starter Lab Station .....EB-6336  
 Agricultural Science Extension Lab Station.....EB-6337

Water Quality Field Guide.....PS-2829A  
 Wireless Magnetic Field Sensor .....PS-3221



CO<sub>2</sub> Sensor shown in use with Dissolved CO<sub>2</sub> Waterproof Sleeve.

## Wireless CO<sub>2</sub> Sensor

PS-3208

Measure changes in carbon dioxide (CO<sub>2</sub>) gas levels quickly and easily with the Wireless CO<sub>2</sub> Sensor. This temperature-compensated sensor can operate in high humidity environments, such as the included 250-mL sample bottle, and employs live data to make core labs such as photosynthesis, cellular respiration, and metabolism experiments engaging and impactful. With the ability to store more than 55,000 data points, the sensor also supports long-term studies of carbon cycling that span the course of a single night or an entire weekend.

**Features:**

- Logging ability for long-term experiments, store up to 55,000 data points
- Integrated stopper for use with sample bottle and common glassware
- Temperature compensated for accurate results



The sleeves are waterproof but allow CO<sub>2</sub> gas to pass through the membrane, creating a headspace around the sensor.

**Order Information**

Wireless CO <sub>2</sub> Sensor (Carbon Dioxide) .....	PS-3208
Wireless CO <sub>2</sub> Sensor Pack .....	PS-3341
<b>Note:</b> Price for multi-sensor packs includes 8 sensors and custom storage case.	
Dissolved CO <sub>2</sub> Waterproof Sleeve.....	PS-3545

## Wireless Soil Moisture Sensor

PS-3228

The Wireless Soil Moisture Sensor measures the volumetric water content (%VWC) of soil, reporting data in real time or storing it onboard the sensor's memory for long-term experiments. Durable and easy to use, the Wireless Soil Moisture Sensor is the perfect tool for monitoring controlled experiments in the classroom and long-term experiments outdoors. From experiments in evaporation and soil composition to water consumption and plant competition, the Wireless Soil Moisture Sensor makes it easy for students to investigate a wide array of topics through real-time or long-term data collection.

**Features:**

- Collect and display data in real time within PASCO Capstone or SPARKvue software
- Automate data collection for hours, days, or weeks with Logging Mode
- Bluetooth connectivity enables use in the classroom, lab, or field
- Supports use of GPS data from a mobile device for GIS mapping activities
- Selectable calibrations for predominantly sandy soils, clay soils, and loamy soils



**Order Information**

Wireless Soil Moisture Sensor.....	PS-3228
------------------------------------	---------



## Wireless Weather Sensor with GPS

PS-3209

The Wireless Weather Sensor is an all-in-one instrument for monitoring complex environmental conditions. It houses several sensing elements within a single unit to provide 19 different measurements. Use the sensor in logging mode with the Weather Vane Accessory for long-term monitoring, or use it as a handheld instrument to study microclimates and local weather patterns. The collected data can be wirelessly exported to most devices, including classroom device dashboards, making it easier to support group activities that are constrained by time. Plus, with the built-in GPS, students can collect and analyze location data using the SPARKvue map display, powered by ESRI ArcGIS.

### Features:

- Logging mode for long-term experiments
- Water resistant for extended environmental monitoring
- Built-in light sensor measures light level and UV index
- SPARKvue map display supports spatial analysis (GIS)
- 19 different measurements can be collected and analyzed individually or simultaneously
- GPS enables data from any PASCO probe to be viewed on a map, when connected



Visualize your data in seconds with a FREE ESRI's ArcGIS account!

## Measurements

### Weather

1. Ambient Temperature
2. Barometric Pressure
3. Wind Speed
4. Wind Direction (true)
5. Relative Humidity
6. Absolute Humidity
7. Dew Point
8. Wind Chill
9. Heat Stress Index

### Light

10. Ambient Light (lux)
11. UV Index
12. PAR
13. Irradiance

### GPS

14. Latitude
15. Longitude
16. Altitude
17. Speed
18. Magnetic Direction
19. True Direction



The weather dashboard displays data from the multiple sensors.



Weather Vane Accessory sold separately.

## Order Information

Wireless Weather Sensor with GPS .....PS-3209

Wireless Weather Sensor with GPS Pack.....PS-3340

**Note:** Price for multi-sensor packs includes 8 sensors and custom storage case.

Weather Vane Accessory .....PS-3553



## Wireless Temperature Sensor



PS-3201

Welcome to the modern thermometer. The Wireless Temperature Sensor transmits live data and allows students to continuously monitor, log, and plot temperature measurements on nearly any device. When lab-time ends but the experiment continues, students can set the sensor to log data autonomously for days, weeks, or months, then download it for analysis later. This durable, wireless sensor features a stainless steel probe for the most demanding of applications, as well as a battery that lasts over a year\*. It can be used in a wide array of experiments and activities because it measures small, but significant temperature changes produced by chemical reactions, convection currents, and even skin temperatures.

### Features:

- Simply pair and go, no cables or adapters to manage
- Variable sampling rate for capturing small, fast changes or experiments that run for hours, days, or weeks
- Bluetooth® connectivity and long-lasting coin cell battery
- Logs temperature data directly onto the sensor for long-term experiments
- Dust, dirt, and sand-proof and water resistant (IP-X7 certified)

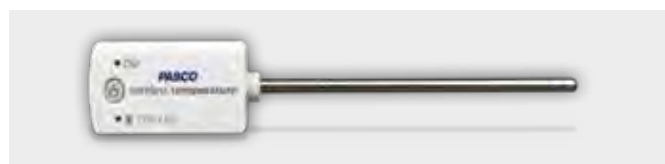
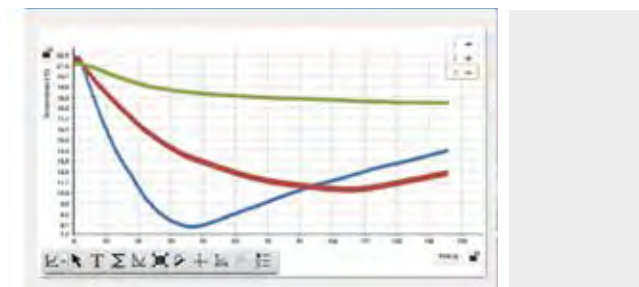

### Order Information

Wireless Temperature Sensor.....PS-3201

Wireless Temperature Sensor Pack .....PS-3330

**Note:** Price for multi-sensor packs includes 8 sensors and custom storage case.



## Wireless pH Sensor



PS-3204

The Wireless pH Sensor is a must-have for any chemistry, biology, or environmental science course. Equally capable in the lab or field, the sensor eliminates the hassle of cables, reducing spills and improving safety. Plus, it rarely requires charging; the sensor's coin cell battery lasts for 2-3 years in most labs and costs about one dollar to replace. It can transmit data in real time, or store data for days when continuous monitoring is required. The Wireless pH Sensor enhances countless activities, including acid-base titrations, investigations into household chemicals, analyses of chemical reactions, water quality studies, and much more.

### Features:

- Simply pair and go, no cables or interfaces to manage
- Compatible with ion-selective electrodes (ISE) and the oxidation reduction probe (ORP)
- Bluetooth® connectivity and a long-lasting coin cell battery
- Logs pH data directly onto the sensor for long-term experiments
- Wirelessly connects to SPARKvue and Capstone for intuitive analysis and lab reports



Measure the pH of water in different locations and annotate with text and pictures.



### Order Information

Wireless pH Sensor.....PS-3204

Wireless pH Sensor Pack .....PS-3331

**Note:** Price for multi-sensor packs includes 8 sensors and custom storage case.





## Wireless Conductivity Sensor

PS-3210A

The Wireless Conductivity Sensor measures the electrical conductivity of an aqueous solution. It is ideal for investigating the properties of solutions, including total dissolved solids (TDS) for water quality inquiry. Because it is temperature compensated, calibrations are less frequent and can be applied across a range of temperatures. With an improved range of 0 to 40,000  $\mu\text{S}/\text{cm}$ , this sensor can be utilized for chemical, biological, and environmental studies.

Teacher tip: To measure brackish or marine samples, perform a dilution until the measurement falls within the range, then multiply by that factor to determine sample conductivity.

### Features:

- Measure conductivity and total dissolved solids
- Automatic temperature compensation
- Battery life >1 year
- Remote logging with built-in memory
- Dust-proof, sand-proof, and water-resistant (1 meter for 30 minutes)



### Order Information

Wireless Conductivity Sensor .....PS-3210A

Wireless Conductivity Sensor Pack.....PS-3332

**Note:** Price for multi-sensor packs includes 8 sensors and custom storage case.



## Wireless Light and Color Sensor

PS-3248

The Wireless Light and Color Sensor features two separate apertures: One measures ambient light from the side of the box, and the other measures percent color of directional light at the end of the box.

### Features:

- Wirelessly connects to computers, Chromebooks, tablets, and smartphones
- Simply pair and go, no cables or adapters to manage
- On-board memory enables the sensor to function as an independent datalogger
- Variable sampling rate for short, precise experiments or lengthy, multi-day data collection.
- Bluetooth connectivity and long-lasting coin cell battery
- Indirect PAR measurements for biological studies

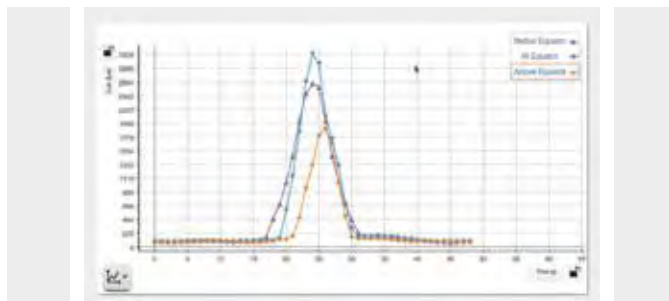

### Order Information

Wireless Light and Color Sensor .....PS-3248

Wireless Light Sensor Pack.....PS-3338

**Note:** Price for multi-sensor packs includes 8 sensors and custom storage case.



## Density Circulation Model

ME-6816

The PASCO Density Circulation Model allows students to model, measure and understand the complex density-driven circulation associated with heat transfer through convection. Students can recreate vertical ocean currents driven by water bodies with density differences. They can extend this learning by using sensors to collect data and create graphs showing the thermocline, halocline and pycnocline using a Salinity Sensor PS-2195 (page 81).

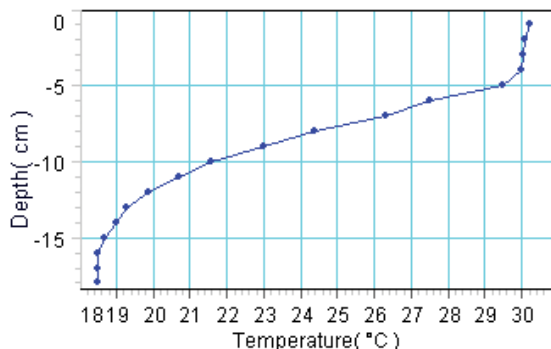

### Order Information

Density Circulation Model .....ME-6816



## Wireless Optical Dissolved Oxygen Sensor

PS-3246

The Wireless Optical Dissolved Oxygen (ODO) Sensor is ideal for monitoring DO<sub>2</sub> in the lab or field. The Wireless Optical DO Sensor contains three different probes. In addition to the dissolved oxygen sensor, it also includes probes for measuring atmospheric pressure and water temperature. The optical technology is fast, accurate, and does not require stirring, filling solutions, warm-up, or frequent calibration. The included waterproof probe is submersible to a depth of 2.5 m. The sensor box is not waterproof.

A PASCO exclusive feature allows you to log data using the sensor's built-in memory. After collecting data for hours or even days, simply connect the sensor to your device and you're ready to download your data. With this powerful sensor, educators can explore day and night nutrient cycles, changes in metabolic processes, seasonal changes in water quality, and more.



### Order Information

Wireless Optical Dissolved Oxygen Sensor .....PS-3246



## EcoZone System

ME-6668

PASCO's EcoZone System is designed to help students model and understand complex interactions within, and among, different ecosystems. The three clear, acrylic EcoChambers are specially designed to accommodate PASCO sensors, making qualitative and quantitative measurements easily accessible.

Students can use the interconnected chambers to model interactions between three different ecosystems. Choose the traditional terrestrial, aquatic, and decomposition environments, or create unique biomes to model and measure. With the EcoZone System, students can create two identical ecosystems for precise control of variable impact, decouple the system for isolated investigations, or connect all three chambers to study interactions.

### Features:

- Total volume of each chamber is 4,534 cm<sup>3</sup>
- Sturdy construction designed for easy setup and cleanup
- Quantitatively study the interaction of different ecosystems
- Custom molded for use with PASCO sensors
- Clear acrylic allows for observations from all sides

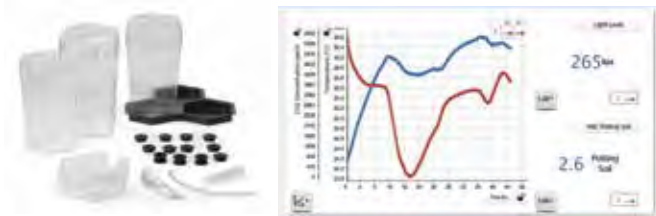

### Order Information

EcoZone System .....ME-6668



## Greenhouse Sense & Control Kit

ST-2997

Designed for the exploration of biological and ecological concepts, the Greenhouse Sense & Control Kit includes everything students need to design, build, program, and study their very own greenhouse.

### Build career awareness with activities that make real-world connections to:

- Agricultural monitoring
- Ecological management
- Plant physiology

### Help students develop competency in:

- Coding
- Problem solving
- Data collection and analysis
- Ecological concepts
- Science & Engineering practices

This kit includes an EcoChamber, //control.Node, Power Output Module, Soil Moisture Probe, USB Fan and Water Pump, PASCO Grow Light, Greenhouse Accessory Kit, and a Greenhouse Sensor that measures light, temperature, humidity, and soil moisture.



### Order Information

Greenhouse Sense and Control Kit .....ST-2997



## Wireless Colorimeter & Turbidity Sensor

PS-3215

The Wireless Colorimeter & Turbidity Sensor simultaneously measures the absorbance and transmittance of six different wavelengths. The sensor can be used to study Beer's Law (absorbance vs. concentration), enzyme activity, photosynthesis, and the rates of chemical reactions (absorbance vs. time). After a simple calibration, students can quickly begin viewing live measurements as they materialize across the visible spectrum at 650 nm (red), 600 nm (orange), 570 nm (yellow), 550 nm (green), 500 nm (blue), and 450 nm (violet).

This sensor also functions as a high-quality turbidimeter for water quality analysis. Rather than simply measuring transmitted light, the Wireless Colorimeter and Turbidity Sensor measures light scattered at a 90 degree angle from the sample, resulting in accurate and repeatable measurements. Additionally, the internal housing for the cuvette is opaque, which limits ambient light interference to preserve accuracy.

### Features:

- Stabilized light source for consistent readings
- Measures six different wavelengths simultaneously
- PASCO software displays the absorbance & transmittance at each wavelength in the appropriate color
- Quick and easy calibration
- Wireless design enables data collection in the field
- Pre-calibrated for ezSample Snap Vial Kits



Measure the absorbance and transmittance of a solution at six different wavelengths... simultaneously!

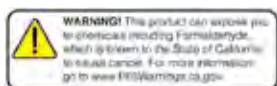

## Chemical Water Quality Testing in the Field

PASCO's ezSample water quality test kits simplify the chemical testing of water sources. Avoid the mess and difficulty of handling chemicals directly and get great results, even in the field.

### Colorimetric Analysis

Conduct colorimetric tests in the field and avoid the mess and tedium of mixing chemicals. These ezSample Snap Vials contain a pre-formulated reagent to test a variety of water quality parameters. No more guessing at color variations—drop the vial into the Water Quality Colorimeter and read the concentration.



### Order Information

ezSample Snap Vial - Iron .....	EZ-2331
ezSample Snap Vial - Nitrate* .....	EZ-2333B
ezSample Snap Vial - Ammonia .....	EZ-2334A
ezSample Snap Vial - Phosphate.....	EZ-2337
ezSample Snap Vial - Chlorine .....	EZ-2339A
ezSample Field Titrator - Total Hardness .....	EZ-2338
ezSample Field Titrator - Carbon Dioxide**.....	EZ-2341
ezSample Field Titrator - Alkalinity .....	EZ-2340

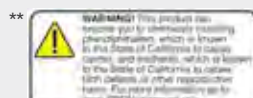
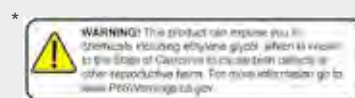

### Order Information

Wireless Colorimeter & Turbidity Sensor.....PS-3215  
 Includes USB charging cable, 9 cuvettes, 2 cuvette racks, and one 100 NTU calibration cuvette.  
 Wireless Colorimeter & Turbidity Sensor Pack .....PS-3334  
**Note:** Price for multi-sensor packs includes 8 sensors and custom storage case.

## PASPORT Salinity Sensor

PS-2195

The PASPORT Salinity Sensor works with the 10X Salinity Sensor Probe to measure the salinity, conductivity, and temperature of fresh to brackish water sources. The sensor determines salinity based on electrical conductivity. It also features a built-in calculation, based on the Practical Salinity Scale (PSS), that compensates for changes in conductivity caused by temperature changes.



### Order Information

PASPORT Salinity Sensor .....PS-2195

## PASPORT Non-Contact Temperature Sensor

PS-2197

The Non-Contact Temperature Sensor measures surface temperature by detecting the emitted infrared light. Record the temperature of objects without touching them!



### Order Information

PASPORT Non-Contact Temperature Sensor .....PS-2197

## Go Wireless with PASPORT Sensors

PASCO's AirLink Interface connects PASPORT (blue) sensors to your computer using Bluetooth or USB technology.



## PASPORT Flow Rate/Temperature Sensor

PS-2130

PASCO's Flow Rate Sensor allows students to measure the temperature and rate of movement of streams, rivers, and other flowing systems. The propeller is a rugged, single-piece unit encased by protective material — no more losing pieces at the bottom of the stream.

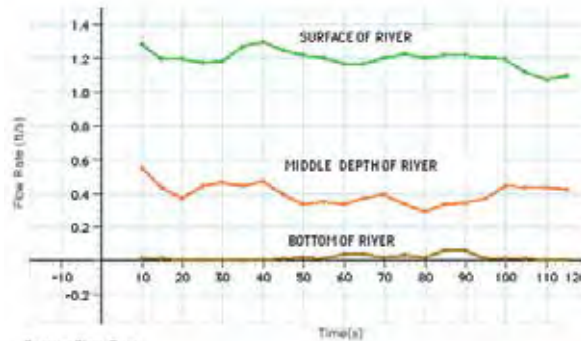

Stream Flow Rate

Graph shows the flow rates at the top (green), middle (orange), and bottom (brown) of a stream.



### Order Information

PASPORT Flow Rate/Temperature Sensor .....PS-2130

## AirLink Interface

PS-3200

The AirLink connects PASPORT sensors to a Mac or Windows computer, Chromebook, iPad, tablet, or smartphone via Bluetooth or USB connection. The USB cable is included.



### Order Information

AirLink Interface .....PS-3200

## PASCO's Integrated Solutions for Physics

At PASCO, we aim to provide high school physics educators with the most groundbreaking solutions on the market. Our physics solutions pair wireless, cross-platform technology with engaging, hands-on labs to help foster active science learning.

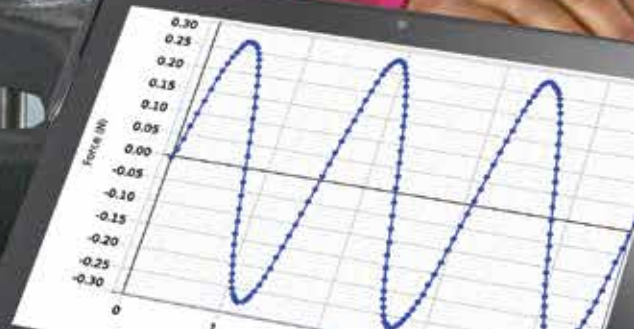



## Physics Solutions for General, Honors, IB®, and AP® Physics

Perform more hands-on physics labs with PASCO. Our award-winning sensors, Essential curriculum, and data-collection software let students discover physics through hands-on experimentation. Whether you teach Honors, IB®, AP® Physics 1 or 2, or General Physics, you're sure to find a PASCO solution that's right for you and your students.

Are you receiving our Physics Catalog?  
It includes our full line of physics equipment!  
[pasco.com/catalogs](http://pasco.com/catalogs)



### Physics Index

Mechanics, Physics Lab Stations .....	86
Fluids, Physics Lab Station.....	88
Electricity & Magnetism, Physics Lab Station .....	89
Optics, Physics Lab Station.....	90
Waves and Sound, Physics Lab Station .....	91
Essential Physics Curriculum & Equipment.....	92
Modular Circuits .....	94
MatchGraph Free Motion Graphing Software .....	96
Wireless Smart Cart .....	97
Smart Cart Demo Kit and Accessories .....	98
Wireless Rotary Motion Sensor.....	100
Wireless Smart Gate and Launchers .....	101
Wireless Spectrometer & Sound Sensor.....	102
Wireless Geiger Counter.....	105
Wireless Force Platforms.....	107
SPARK LXi2 & the 550 Universal Interface.....	108
Interface Comparison .....	109
PASCO Capstone.....	110

# Physics Lab Station: Mechanics Starter

The Physics Lab Station: Mechanics Starter bundle is a lab-ready solution for performing several key experiments in mechanics. It includes a sensor-loaded Smart Cart, a durable PAstrack, and a variety of accessories that support student studies of core topics such as velocity, conservation of energy, and Newton's second law.

**Real-Time Sensor Measurements**—Students can use the Smart Cart's built-in sensors to make real-time measurements of position, velocity, acceleration, force, and rotation, displaying them as the lab unfolds for more meaningful learning. They can also collect and compare data from multiple trials, easily apply lines of fit, and perform statistical analysis using PASCO software.

**Ready-Made Mechanics Labs**—This kit is complemented by a collection of ready-made experiments that can be downloaded for free from the Experiment Library. Each lab comes ready-to-use with editable student handouts, teacher answer keys, and helpful teaching tips.

### Perform These Experiments:

- Average Speed and Velocity
- Graphing Motion
- Speed and Velocity Graphs
- Conservation of Energy
- Work and Kinetic Energy
- Newton's Second Law
- Coefficients of Friction
- Momentum and Impulse
- Periodic Motion: Mass and Spring



### Mechanics Starter Equipment List

Equipment	Part #	Qty.
Smart Cart (red)	ME-1240	1
Smart Cart Rod Stand Adapter	ME-1244	1
Cart Mass (set of 2)	ME-6757A	2
PAstrack	ME-6960	1
Aluminum Meter Stick		1
Dynamics Track End Stop (2 pack)	ME-8971	1
Small "A" Base	ME-8976	1
Stainless Steel Rod, 60 cm Threaded	ME-8977	1
Mass & Hanger Set	ME-8979	1
Dynamics Track Spring Set	ME-8999	1
Super Pulley Kit	ME-9433	1
Angle Indicator	ME-9495A	1
Multi-Clamp	ME-9507	1
Friction Block	ME-9807	1
Track Rod Clamp	ME-9836	1
Bumper Accessory Set	ME-9884	1



### Order Information

Physics Lab Station: Mechanics Starter.....ME-5300



# Physics Lab Station: Mechanics Extension

The Physics Lab Station: Mechanics Extension bundle expands your physics toolbox, allowing students to explore topics such as statics, rotation, projectile motion, and periodic motion. It includes an additional Smart Cart for studying collisions, a Mini Launcher for firing projectiles, and a Wireless Smart Gate for timing events accurately. A variety of accessories are also included.

**Real-Time Sensor Measurements**—Students can use the Wireless Smart Gate and patented Smart Cart to monitor key measurements in real time, displaying them as the lab unfolds for more meaningful learning. Use the Smart Cart’s built-in sensors to measure motion on or off the track, or time events with precision using the dual-beam Wireless Smart Gate. Students can also collect and compare data from multiple trials, easily apply lines of fit, and perform statistical analysis using PASCO software.

**Ready-Made Mechanics Labs**—This kit is complemented by a collection of ready-made experiments that can be downloaded for free from the Experiment Library. Each lab comes ready-to-use with editable student handouts, teacher answer keys, and helpful teaching tips.

## Perform These Experiments:

- Conservation of Momentum
- Momentum and Explosions
- Simple Pendulum
- Atwood’s Machine
- Two Dimensional Motion: Projectiles
- Exploring Torque
- Exploring a Rotating System
- Momentum and Impulse
- Exploring Physical Pendulums



## Mechanics Extension Equipment List

Equipment	Part #	Qty.
Smart Cart (Blue)	ME-1241	1
Photogate Mounting Bracket	ME-6821A	1
Mini Launcher	ME-6825B	1
Pivot	ME-7034	1
Meter Stick Torque Mass Hanger Set	ME-7035	1
Photogate Pendulum Set	ME-8752	1
Pendulum Clamp	ME-9506	1
Photogate Wireless Smart Gate	PS-3225	1



## Order Information

Physics Lab Station: Mechanics Extension .....ME-5301

Required:

Physics Lab Station: Mechanics Starter.....ME-5300

# Physics Lab Station: Fluids

The Physics Lab Station: Fluids bundle enables students to perform several essential experiments in fluids. It includes a Wireless Pressure Sensor for making measurements of pressure in liquids and gases. A Density Set and Overflow Can are included for measuring buoyant forces in fluids.

**Real-Time Sensor Measurements**—Students can use the Wireless Pressure Sensor to make real-time measurements of pressure in liquids or gases, displaying them as the lab unfolds for more meaningful learning. They can also collect and compare data from multiple trials, easily apply statistics, and export their data using PASCO software.

**Ready-Made Fluids Labs**—This kit is complemented by a collection of ready-made experiments that can be downloaded for free from the Experiment Library. Each lab comes ready-to-use with editable student handouts, teacher answer keys, and helpful teaching tips.

### Perform These Experiments:

- Boyle’s Law
- Hydrostatic Pressure
- Buoyant Force



### Fluids Equipment List

Equipment	Part #	Qty.
Wireless Pressure Sensor	PS-3203	1
Density Set	ME-8569A	1
Overflow Can	SE-8568A	1



### Order Information

Physics Lab Station: Fluids.....ME-2040  
 Required:  
 Physics Lab Station: Mechanics Starter.....ME-5300

# Physics Lab Station: Electricity and Magnetism

This lab-ready equipment set supports experiments in electricity and magnetism across all levels of physics. It includes Wireless Voltage, Current, and Magnetic Field Sensors, an Essential Physics Modular Circuits Kit, and an Electronic Components Kit.

**Textbook Circuits for the Real World**-The Essential Physics Modular Circuits Kit brings 2D circuitry to the real world, allowing students to study and measure circuits using components that look like textbook models. Each square piece displays both the physical component (resistor, capacitor, etc.) and the schematic to help bridge the gap between circuit diagrams and functioning circuits.

**Real-Time Measurements**-Students can use the Wireless Voltage and Current Sensors to make measurements anywhere in their circuit. Voltage and current readings are displayed in real time, allowing students to quickly compare and contrast different circuit configurations. They can also use PASCO software to collect and compare data, apply lines of fit, and perform statistical analysis.

**Ready-Made Electricity & Magnetism Labs**-This kit is complemented by a collection of ready-made experiments that can be downloaded for free from the Experiment Library. Each lab comes ready-to-use with editable student handouts, teacher answer keys, and helpful teaching tips.

## Perform These Experiments:

- Ohm's Law
- DC Circuits
- Capacitors and RC Circuits
- Magnetic Field of a Permanent Magnet
- Electromagnetic Induction
- Magnetic Field in a Coil
- Planck's Constant



## Electricity & Magnetism Equipment List

Equipment	Part #	Qty.
Essential Physics Modular Circuits Kit	EM-3536	1
Wireless Current Sensor Module*	EM-3534	1
Wireless Voltage Sensor*	PS-3211	1
Wireless Magnetic Field Sensor	PS-3221	1
Electronic Components Kit	EM-8818	1

\* Included with EM-3536



## Order Information

Physics Lab Station: Electricity and Magnetism.....EM-3557

# Physics Lab Station: Optics

The Physics Lab Station: Optics bundle is a lab-ready solution for performing a wide range of optics experiments – from introductory investigations of lenses to advanced experiments in Snell’s Law. It includes a Basic Optics Ray Table, a Light Source, Concave and Convex Mirrors, and various lenses and accessories. The included equipment mounts easily to a PASCO Dynamics Track or a 1.2m Optics Track (sold separately) for hassle-free alignment.

**Ready-Made Optics Labs**—This kit is complemented by a collection of ready-made experiments that can be downloaded for free from the Experiment Library. Each lab comes ready-to-use with editable student handouts, teacher answer keys, and helpful teaching tips.

### Perform These Experiments:

- Spherical Mirror Reflection
- Snell’s Law
- Focal Length of a Converging Lens
- Virtual Images
- Telescope and Microscope
- Shadows



### Optics Equipment List

Equipment	Part #	Qty.
Concave/Convex Mirror	OS-8457	1
Basic Optics Viewing Screen	OS-8460	1
Basic Optics Ray Table	OS-8465	1
Basic Optics Light Source	OS-8470	1
Dynamics Track Optics Carriages (Set of 4)	OS-8472A	1
Basic Optics Geometric Lens Set	OS-8456	1
Accessory Lens Set	OS-8519	1



### Order Information

Physics Lab Station: Optics .....OS-8910

Required:

Physics Lab Station: Mechanics Starter.....ME-5300

Or:

Optics Track, 1.2 m.....OS-8508

# Physics Lab Station: Waves and Sound

The Physics Lab Station: Waves & Sound bundle is a lab-ready solution for performing a variety of experiments in waves and sound. It includes a 2-in-1 Wireless Sound Sensor, a complete Tuning Fork Technical Set, a high-quality Resonance Air Column, and a Double-Length Slinky.

**Real-Time Sensor Measurements**—The Wireless Sound Sensor gives students unparalleled insight into the physics of sound and waves. Students can use the sensor to measure the frequency of a sound wave, and then visualize the waveform using PASCO software. Students can use the Double-Length Slinky to create a waveform with a partner, then use PASCO software to easily measure sound waves for further analysis.

**Ready-Made Sound and Wave Labs**—This kit is complemented by a collection of ready-made experiments that can be downloaded for free from the Experiment Library. Each lab comes ready-to-use with editable student handouts, teacher answer keys, and helpful teaching tips.

## Perform These Experiments:

- Resonance and Standing Waves
- Properties of Sound Waves
- Measuring the Speed of Sound
- Decoding DTMF Tones



## Waves and Sound Equipment List

Equipment	Part #	Qty.
Wireless Sound Sensor	PS-3227	1
Tuning Fork Technical Set	SE-7728	1
Resonance Air Column	WA-9606	1
Double-Length Slinky	SE-8760	1



## Order Information

Physics Lab Station: Waves and Sound .....WA-9515

# Essential Physics - Your COMPLETE Physics Solution



**PASCO's Essential Physics** is the only curriculum solution that includes a Student Textbook, Student e-Book, Teacher e-Resources, Student Lab Manual, and Equipment Kits, all at a very affordable price. This 3-D STEM program includes a full year of instruction for both General and Honors Physics classes. Use our complete solution or integrate Essential Physics into your existing curriculum.

## Student Textbook & Lab Investigations

- 27 chapters cover a full year of instruction for High School General and Honors Physics programs
- One main idea per page
- Quality illustrations
- Section and Chapter reviews
- 82 complete investigations
- 8 Engineering Design Projects

## Student e-Book

- Browser-based version of the textbook
- Same layout with convenient 24/7 online access
- Embedded videos and animations bring content to life
- Interactive equations and simulations enrich key concepts
- Formative and summative assessment questions

## Teacher e-Resources for Lab Manual

- SPARKvue software
- Editable documents
- PowerPoint presentations
- Answer keys
- Video lab assistance

Essential Physics is multiplatform and works on iOS, Android™, Chrome™, Windows®, and Mac®. What's more, it includes 24/7 online access, as well as correlations to NGSS and your state standards.

## Teacher e-Resources for Textbook

- Infinite Test Bank
- Teacher User Guide
- Teacher e-Book (1-year or multi-year license)
- Alignment details for NGSS and state standards

## PASCO Academy Physics Resources

- Available through your PASCO Educator account
- 25 engaging video labs with detailed instruction and data collection
- 25 datasets for student analysis and discussion
- 25 editable lab handouts with teacher answer keys
- Digital access to more than 80 labs for General and Honors Physics

## Essential Physics correlates with NGSS and is constructed around the three dimensions:

- Science and Engineering Practices
- Crosscutting Concepts
- Disciplinary Core Ideas



# Textbook + e-Book + Equipment

## **Essential Physics (3rd Edition) Student Textbook** EP-6323

This rigorous yet accessible textbook includes core physics topics that cover a complete year of instruction for both High School General and Honors Physics classes. The lessons follow the 5E model and include tools for ELL students, as well as tools for students with different learning styles. The curriculum aligns to NGSS and your state standards for both regular and advanced coursework. The accessible textbook includes one main idea per page, quality illustrations, 89 complete investigations, eight Design Projects, and Section and Chapter Reviews. The 27 chapters cover these topics:

- Science of Physics
- Physical Quantities and Measurement
- Position and Velocity
- Acceleration
- Forces and Newton's Laws
- Motion in Two and Three Dimensions
- Circular Motion
- Static Equilibrium and Torque
- Work and Energy
- Conservation of Energy
- Momentum and Collisions
- Machines
- Angular Momentum
- Harmonic Motion
- Sound Waves
- Electricity and Circuits
- Electric and Magnetic Fields
- Electromagnetism
- Light and Reflection
- Refraction and Lenses
- Electromagnetic Radiation
- Properties of Matter
- Heat Transfer
- Thermodynamics
- Quantum Physics and the Atom
- Nuclear Physics

## **Essential Physics Student e-Book**

The Student e-Book is an electronic version of the full textbook with interactive elements. Throughout the electronic text, content and theory are supported with optional audio reading, as well as interactive elements, such as digital equations, videos, animations, and simulations. Students also have the option of expanding the content using the 'more' button to go deeper into concepts.

## **Essential Physics Labs & PASCO Equipment Bundles**

Use PASCO's Physics Lab Stations to perform the following hands-on investigations from *Essential Physics*.

### **ME-5300 Physics Lab Station: Mechanics Starter**

- **1A:** Graphs of motion
- **3B:** Motion graphs
- **4A:** Acceleration
- **4B:** A model for accelerated motion
- **5A:** Newton's second law
- **5B:** Hooke's law
- **5C:** Static and kinetic friction
- **6C:** Acceleration on an inclined plane
- **9A:** Work and the force versus distance graph
- **10A:** Inclined plane and the conservation of energy
- **10B:** Work and energy
- **10C:** Springs and the conservation of energy
- **10D:** Work done by friction
- **11C:** Elastic collisions
- **12C:** Ramps and inclined planes

### **ME-5301 Physics Lab Station: Mechanics Extension**

- **6B:** Projectile motion
- **11A:** Conservation of momentum
- **11B:** Inelastic collisions
- **14A:** Oscillators
- **14C:** Resonance

### **EM-3557 Physics Lab Station: Electricity and Magnetism**

- **17A:** Electricity and circuits
- **17B:** Voltage and batteries
- **17C:** Resistors and Ohm's law
- **17D:** Series and parallel circuits
- **17E:** Electrical power
- **17F:** Compound circuits
- **18A:** Magnetic force between magnets

### **OS-8910 Physics Lab Station: Optics**

- **20A:** Magnification of mirrors and lenses
- **20B:** Reflection in a plane mirror
- **20C:** Image formation for curved mirrors
- **21A:** Refraction of light
- **21B:** Creating real and virtual images with lenses
- **21C:** Image formation for a convex lens
- **21D:** Build a microscope and a telescope

### **WA-9515 Physics Lab Station: Waves and Sound**

- **15A:** Waves
- **15C:** Interference
- **16D:** Resonance and Sound

### **Additionally, the following labs can be performed with the Simple Machines Kit (EP-3577):**

- **8A:** Static equilibrium
- **12A:** Levers
- **12B:** Pulleys





Learn more at [pasco.com/circuits](http://pasco.com/circuits)

## Basic Modular Circuits Kit

EM-3535

These circuit modules are designed specifically for introductory circuit investigations. For students who have never wired a circuit, this modular system makes it easy for them to see their circuit physically laid-out exactly as it appears in their circuit diagram.

Each module connects mechanically to another by sliding the tabs into each other. It works on any tabletop. No special surface is required. To electrically connect two modules, students insert a jumper clip, which emphasizes that an electrical connection has been made. The large size of the modules (8 cm x 8 cm) enables all the students around the table to see and understand the completed circuit.

*Each module connects mechanically to another by sliding the tabs into each other. To make them visible, many of the components are mounted on top of the module or in a well for protection.*



*The Basic Modular Circuits Kit is a lower cost, introductory set with fewer components than the Essential Physics Modular Circuits Kit. The Wireless Voltage Sensor and Wireless Current Module are not included.*



### Order Information

Basic Modular Circuits Kit.....EM-3535

## Essential Physics Modular Circuits Kit

EM-3536

The Essential Physics Modular Circuits Kit includes more modules, such as the Wireless Current Sensor Module and Wireless Voltage Sensor. The Essential Physics Modular Circuits Kit will also support applications like RC and RLC circuit analysis, electric motors, Kirchhoff's Laws, and much more!

*The Essential Physics Modular Circuits Kit seamlessly integrates sensors, like the Wireless Current Sensor Module & Wireless Voltage Sensor.*

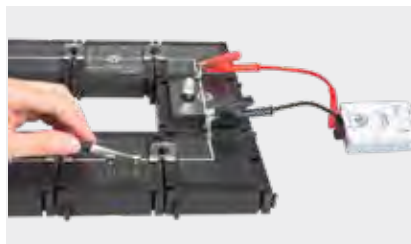

### Order Information

Essential Physics Modular Circuits Kit.....EM-3536  
 Modular Circuits Expansion Kit.....EM-3540



## Compare Modular Circuit Kits

### Kits include these modules and apparatus:

	Basic EM-3535	Essential EM-3536	Expansion EM-3540		Basic EM-3535	Essential EM-3536	Expansion EM-3540
Corner Wire	4	4	2	Battery, AA	2	2	
Straight Wire	4	5	2	Jumper Clips	30	45	15
Tee	2	2	2	Diode	1	1	
Spring	1	1	1	330 ohm Resistor	1	2	
Switch, SPDT	1	1		1000 ohm Resistor	1	2	
Switch, SPST	1	1		100 microfarad Capacitor	1	1	
Resistor	2	3		330 microfarad Capacitor	1	1	
Capacitor	1	1		Magnets, 0.45" x 0.25"	0	8	
Light Bulb	2	3	1	Plotting Compass	0	1	
Potentiometer	0	1		Alligator Clip Jumper Wire	0	1	
Motor	0	1		EM-3534 Wireless Current Sensor	0	1	
LED	0	1		PS-3211 Wireless Voltage Sensor	0	1	
1000 Turn Coil	0	1		Gratnells® Storage Tray	1	1	1
Battery Holder	2	2	1	Banana Jack Terminal			1

## Wireless AC/DC Module

EM-3533

The Wireless AC/DC Module is a Bluetooth® wireless signal generator designed for use with PASCO's Modular Circuits. The AC/DC Module can act as a DC power supply, as well as generate Sine, Triangle, and Square AC signals. A built-in battery provides long lasting power for your basic circuits, and it can be recharged using the included USB cable. An internal voltage sensor monitors the output voltage at all times. The Wireless AC/DC Module is controllable in either PASCO Capstone or SPARKvue software. This latest circuit module expands the number and type of experiments you can perform with Modular Circuits including Ohm's Law, RC Circuit Time Constant, and LRC labs.

Programmable using Blockly programming in PASCO Capstone 2 and SPARKvue software.

### Features:

- Compatible with Modular Circuits
- $\pm 3$  V Output; 0.3 A Max
- DC, Sine, Triangle, Square
- Bluetooth® Low Energy
- Rechargeable Battery
- Controllable with PASCO Capstone or SPARKvue Software



## Perform Circuits Emulations with Modular Circuits and PASCO Capstone 2

### Reinforce circuit concepts and tackle student misconceptions using circuit visualization.

When you use Modular Circuits with PASCO Capstone 2 and its Circuits Emulation tool, you can:

- Construct and modify circuits
- Show conventional current or electron flow animation
- Animate circuits with live sensor data

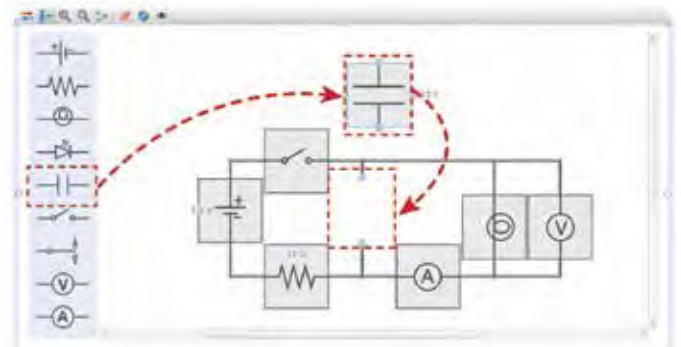

### Order Information

Wireless AC/DC Module .....EM-3533

Learn more about Capstone 2 on pages 110-113.



## Wireless Motion Sensor

PS-3219

The Wireless Motion Sensor connects via Bluetooth® or USB to your device, and uses ultrasound to measure the position, velocity, and acceleration of objects. This enables students to take turns measuring themselves, while the class observes their motion materializing as a graph in real time. The sensor can detect objects ranging from 15 cm to 4.0 m away, and without cables to get in the way, students can explore handheld and ceiling-mounted applications.

### Features:

- Measures position, velocity, and acceleration
- False Target Rejection Technology produces clean data
- Clips directly to PASCO Dynamics Tracks
- Rod clamp for mounting
- 180° pivoting head
- Rechargeable lithium-ion battery
- Bluetooth® and USB connectivity



### Order Information

Wireless Motion Sensor .....PS-3219

Wireless Motion Sensor Pack.....PS-3337

**Note:** Price for multi-sensor packs includes 8 sensors and custom storage case.

## Free MatchGraph! Software

MatchGraph software is the most intuitive way to teach motion graphing. Engage your students with a kinesthetic experience that teaches graphing centered on motion. In MatchGraph, students attempt to match one of the nine provided graphs and are given a score showing how accurately they match the chosen curve. This activity gives them a deeper understanding of interpreting graphs as they see their own position and velocity graphed in real time.

Using a PASCO Motion Sensor, students create graphs of their own motion that they can then analyze. When using a Smart Cart, a real-time motion graph is displayed as students move the cart.

### MatchGraph is great for teaching:

- Fundamental graphing skills
- Basic concepts of position and velocity
- The concept of slope
- What it means when the slope is zero
- How position and velocity graphs relate to each other

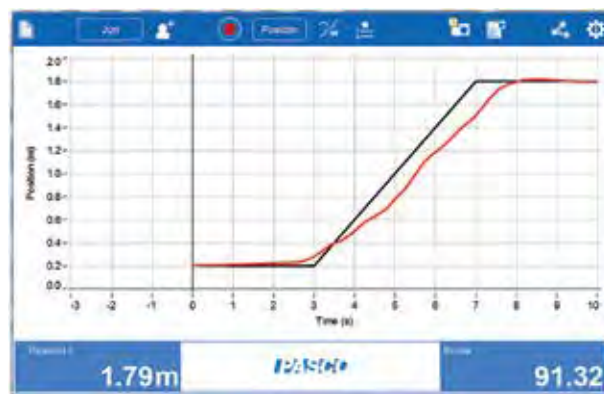

### Download the Free MatchGraph! App



For Mac® and Windows® computers, visit [pasco.com/downloads](http://pasco.com/downloads). Download the free iPad® or Android™ app from the App Store or Google Play.





## Smart Cart (Red/Blue)

ME-1240/ME-1241

The patented Smart Cart is the ultimate tool for studying kinematics, dynamics, Newton's laws, and more. It is based on a durable ABS body with nearly frictionless wheels, just like our high quality PAScars. Now, we've added built-in sensors that measure force, position, velocity, and acceleration. The versatile Smart Cart can collect measurements on or off a track and transmit the data wirelessly over Bluetooth®. In essence, it is a wireless dynamics cart that combines all the necessary sensors, without requiring any additional hardware.

Smart Carts are ideal for studying mechanics topics, such as kinematics and dynamics. The built-in load cells enable two Smart Carts to visually demonstrate Newton's third law with ease. Additionally, built-in sensors for force and acceleration enable students to investigate Newton's second law in minutes. Smart Carts truly are a physics lab on wheels, and now you can own the most advanced physics cart ever created, all without the restrictions of cables.

### Features:

- Built-in  $\pm 100$  N force sensor
- 3-axis accelerometer
- Bluetooth® connectivity
- Rechargeable battery
- Motion encoder measures position and velocity on or off the track
- Magnetic bumper for force sensor
- 3-position plunger
- Mass tray
- Velcro® tabs
- Force sensor hook and rubber bumper

## Smart Cart Charging Garage

ME-1243

Charge up to five Smart Carts at once. Provides storage for the carts and accessory bumpers. Includes power adapter.

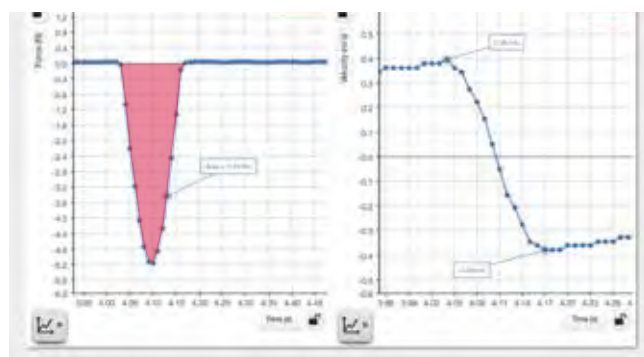

Patent No.  
10,481,173

*The graphs show the impulse experienced and the change in velocity created by a collision between a Wireless Smart Cart and a cardboard bumper.*



*Measure the force exerted directly on the cart when the hook is pulled by a string attached to a mass hanging over a pulley.*

### Order Information

Smart Cart (Red) .....	ME-1240
Smart Cart (Blue) .....	ME-1241
Smart Cart Charging Garage .....	ME-1243



### Smart Cart Demonstration Kits

ME-1272 (RED)/ME-1273 (BLUE)

The Red & Blue Smart Cart Demonstration Kits come with a Smart Cart and all the accessories you need to perform amazing physics demonstrations in kinematics and dynamics.

**Features:**

- Smart Cart (red or blue)
- Smart Fan Accessory
- Two 250-g Cart Masses
- Smart Cart Rod Stand Adapter
- Ballistic Cart Accessory
- Smart Cart Vector Display
- Sail
- Grattells Case
- Demonstration Manual



**Order Information**

Red Smart Cart Demonstration Kit .....ME-1272  
 Blue Smart Cart Demonstration Kit.....ME-1273



### Smart Cart Vector Display

ME-1246

The Smart Cart Vector Display adds visual vectors to your Smart Cart for Force, Acceleration, or Velocity. Connect it to the Smart Cart's accessory port to visualize vectors in real time! The arrows light up proportional to the sensor reading and indicate both magnitude and positive or negative direction.

**Features:**

- Choose from Force, Acceleration, or Velocity vectors, and watch them in real time
- Students can visualize constant acceleration as a cart rolls up and then down an incline
- Great for the student lab station or for a physics lecture demonstration!
- Selectable ranges



**Order Information**

Smart Cart Vector Display .....ME-1246



## Smart Ballistic Cart Accessory

ME-1245

The Smart Ballistic Cart Accessory mounts to any PASCO dynamics cart for a classic demonstration on the independence of X and Y motion. A projectile fired from the accessory while a cart is in motion will be caught farther down the track. When mounted to a PASCO aluminum cart or PAScar, the projectile is launched using a push button timer delay. When connected to a PASCO Smart Cart, the Smart Ballistic Accessory can launch the projectile based on measurements made by the Smart Cart in either SPARKvue or PASCO Capstone software.

### Features:

- Compatible with all PASCO dynamics carts
- Push button timer to delay the launch of the projectile until after the cart is pushed
- Release mechanism does not affect cart motion or ball flight path
- The barrel has X and Y adjustments, so perfect vertical projections can be produced every time
- Fires a colored nylon ball 0.5 meters or higher for impressive demonstrations
- Connects to the Smart Cart for measurement-based launching conditions
- USB rechargeable Li-ion battery



### Order Information

Smart Ballistic Cart Accessory .....ME-1245



## Smart Fan Accessory

ME-1242

What makes this fan so smart? If you use this fan on a regular cart, you can turn it on and select one of three speeds by pushing the button on the side. But plugging it into a Smart Cart gives this Smart Fan Accessory added capabilities:

- **Hands-off Operation:** Turn the Smart Fan on and off wirelessly from your computing device.
- **Adjust the Thrust:** Move the slider in the software and watch the fan respond.
- **Reverse the Spin of the Fan:** Input a negative thrust to make the fan blow in the opposite direction.
- **Set Start and Stop Conditions:** Choose to start the fan when a measurement (such as position) reaches a certain value. Make the fan stop after a certain time, so the cart coasts during part of the experiment.
- **Sense and Control:** Program the Smart Fan thrust to respond to a calculation based on sensor measurements.

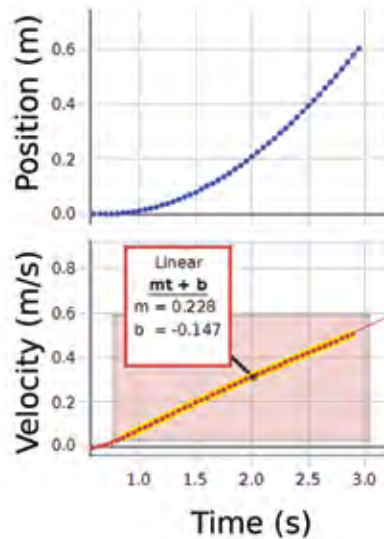

Sample position and velocity data.



### Order Information

Smart Fan Accessory .....ME-1242



**Smart Cart Motor** 

ME-1247

The Smart Cart Motor is a motor-driven wheel that attaches to the Smart Cart to make it go at a constant velocity, forwards or backwards. The motor's power can be wirelessly adjusted from 0 to 100% using either SPARKvue or PASCO Capstone software.



Order Information	
Smart Cart Motor .....	ME-1247



**Wireless Rotary Motion Sensor** 

PS-3220

The Wireless Rotary Motion Sensor measures angle, angular velocity, and angular acceleration, as well as their linear equivalents. The included three-step pulley can be rotated at different rates of acceleration to apply various torques. Use the rod-mounting holes to easily position the sensor for different experiments. This sensor connects directly to your devices via Bluetooth® or USB.

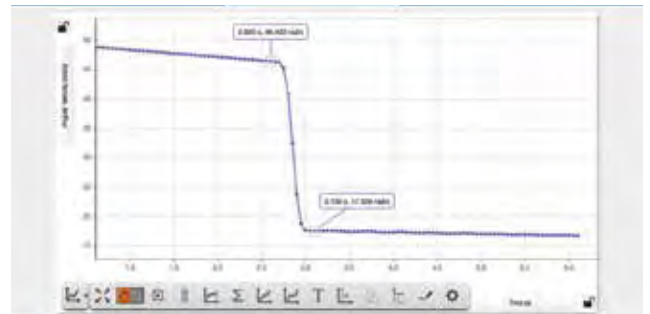

Order Information	
Wireless Rotary Motion Sensor .....	PS-3220

## Wireless Smart Gate

PS-3225

The Wireless Smart Gate is more than just a photogate. It has dual photogate beams spaced 1.5 cm apart to accurately measure speed. When used with a laser, students can use the built-in laser switch to time objects that are too large to fit through the photogate beams. It also includes a photogate tape slot for measuring the movement of objects and an auxiliary port for adding another photogate head or the Time-of-Flight Accessory.

### Highlights:

- Dual photogate beams
- Laser switch
- Auxiliary photogate/ Time-of-Flight port
- Photogate tape slot
- USB and Bluetooth®
- Rechargeable



## Projectile Launcher Wireless Smart Gate System

ME-6796

Choose this wireless option to eliminate cables between the computer and Projectile Launcher. The Wireless Smart Gate has all the features of the Smart Gate (PS-2180), but it connects to your computing device via Bluetooth® or USB; it does not require an interface.

### Includes:

- Wireless Smart Gate with Mounting Bracket
- Launcher with Mounting Stand
- Steel Balls with Loading Rod
- 2-D Collision Accessory
- Aluminum Table Clamp
- 45 cm Stainless Steel Rod

## Mini Launcher

ME-6825B

PASCO's Mini Launcher provides a low-cost method for every student to thoroughly investigate projectile motion. The Mini Launcher has the same level of precision and accuracy as our larger Projectile Launcher (ME-6800), but is easier to assemble, simple to adjust, and provides built-in storage for the plunger and metal balls.



## Projectile Launcher

ME-6800

The Projectile Launcher demonstrates the concept that motion in different dimensions is absolutely independent. A good launcher not only illustrates this non-intuitive idea, but it also describes the exact motion of the projectile. PASCO has precision-engineered the Projectile Launcher to be durable, accurate, and consistent for highly repeatable results.

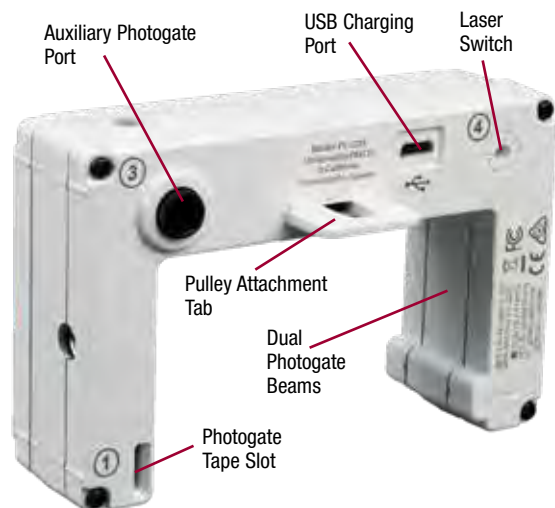

### Order Information

Wireless Smart Gate .....	PS-3225
Mini Launcher.....	ME-6825B
Projectile Launcher Wireless Smart Gate System .....	ME-6796
Projectile Launcher .....	ME-6800

## Wireless Spectrometer (Vis)

PS-2600

The award-winning PASCO Wireless Spectrometer is specifically designed for modern chemistry, biology, and physics labs. It connects to student devices via USB or Bluetooth® Low Energy and includes free Spectrometry software with built-in tools for spectral analysis. Scan times are fast, enabling students to collect a full spectrum of data in less than a second. Three plots are provided for common applications, including Absorbance vs. Wavelength (or Intensity vs. Wavelength), Absorbance vs. Concentration (Beer's law), and Absorbance vs. Time (kinetics).

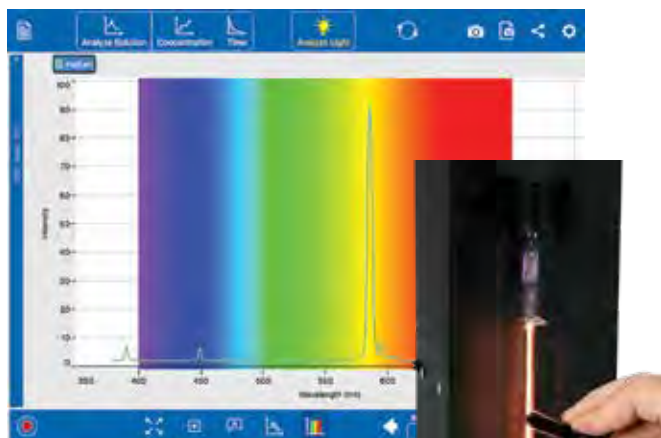

Analyze light sources with the optional Fiber Optic Cable. Easily compare the spectrum to known reference lines in the software.



### Order Information

- Wireless Spectrometer (Vis) .....PS-2600A
- Fiber Optic Cable .....PS-2601



## Wireless Sound Sensor

PS-3227

The Wireless Sound Sensor is two sensors in one wireless package: A sound wave sensor capable of measuring changes in relative pressure level as a function of time, and a sound level sensor with both dBA and dBC-weighted scales.

### Features:

- Wirelessly collects sound wave data at high sample rates (100 kHz)
- Two sound sensors in one (sound wave and sound level)
- High quality sensing element intended specifically for laboratory experiments
- Connects seamlessly to Scope and FFT displays in both SPARKvue and PASCO Capstone software
- Threaded 1/4-20 socket for easy mounting and alignment/positioning

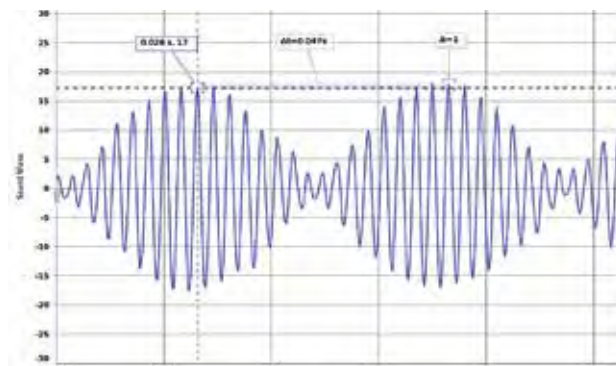

Easily observe and measure beat frequencies

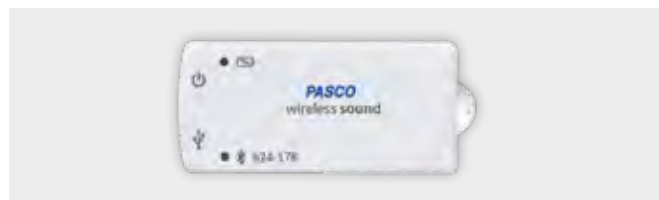

### Order Information

- Wireless Sound Sensor .....PS-3227
- Wireless Sound Sensor Pack.....PS-3342

**Note:** Price for multi-sensor packs includes 8 sensors and custom storage case.



## Wireless Magnetic Field Sensor

PS-3221

This 3-Axis Magnetic Field Sensor can sense the Earth's magnetic field and fields from coils and bar magnets. There are two ranges:  $\pm 50$  gauss and  $\pm 1300$  gauss. This sensor is primarily for static fields.

### Highlights:

- Simultaneous measurements on three axes
- **Dual range:**  $\pm 50$  G and  $\pm 1300$  G
- Sensitive enough to measure the Earth's magnetic field
- Measure fields from bar magnets and coils

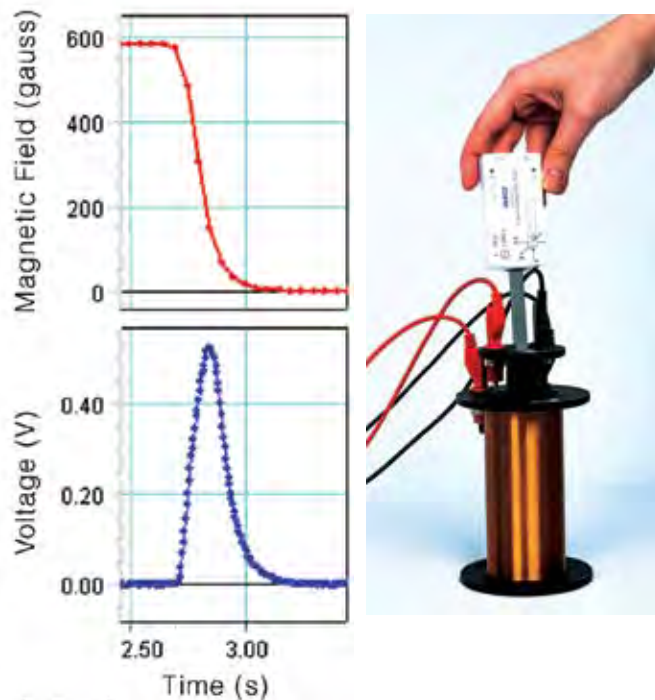

**Order Information**  
 Wireless Magnetic Field Sensor .....PS-3221

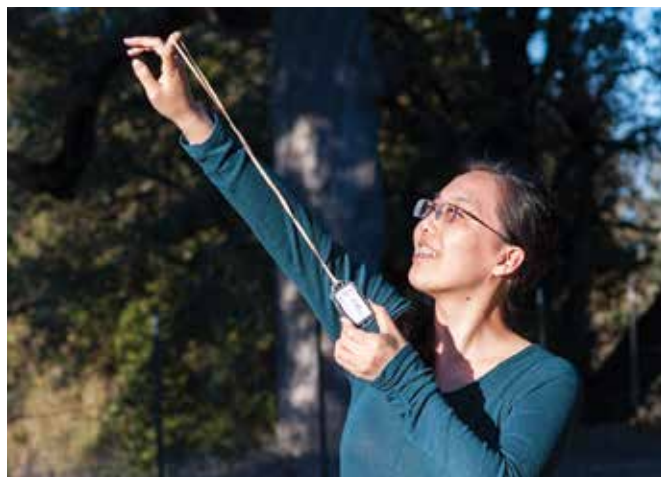

## Wireless Acceleration/Altimeter

PS-3223

The Wireless 3-Axis Acceleration/Altimeter can remotely log acceleration in three dimensions and altitude, making it ideal for recording data during roller coaster rides.

### Specifications:

- Accelerometer Ranges:  $\pm 16$  g,  $\pm 100$  g,  $\pm 200$  g,  $\pm 400$  g
- Measurements: Acceleration (3 axes and resultant); Altitude; Angular Velocity (3 axes)
- Logging: Yes
- Battery: Coin Cell
- Connectivity: Bluetooth® 5.2
- Dimensions: 3.02" x 1.6"

### Highlights:

- 3-axis accelerometer
- 3-axis gyroscope
- Altimeter
- Rubberized case
- Includes mounting strap

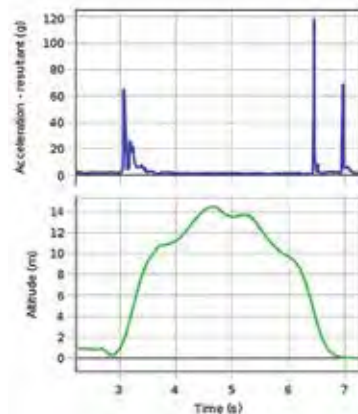

**Order Information**  
 Wireless Acceleration/Altimeter.....PS-3223



## Wireless Pressure Sensor

PS-3203

The Wireless Pressure Sensor allows students to easily collect accurate gas pressure data for a wide range of applications. Included is a 60 cc syringe, tubing, and connectors that facilitate experiments such as Boyle’s law and measuring pinch-grip strength. Within PASCO’s software, students can easily select their desired units from a list containing kPa, mmHg, inHg, mbar, psi, atm, and torr.

### Features:

- Measures pressure even when the pressure within the system drops below ambient pressure
- Supports common units (kPa, atm, psi, mmHg, or N/m<sup>2</sup>) for many applications
- Bluetooth® wireless connectivity and long-lasting rechargeable battery

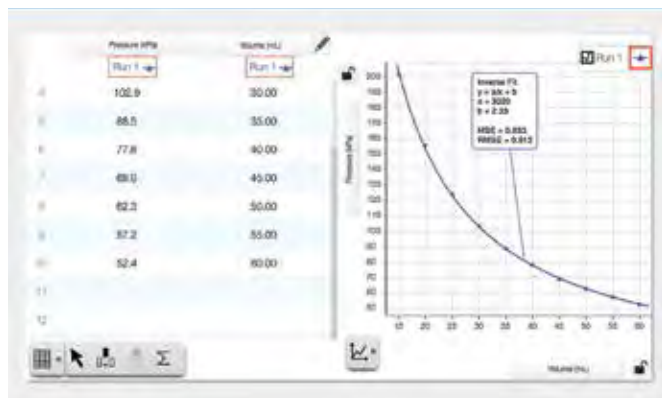

With the included syringe, your students can easily quantify the relationship between pressure and volume.



### Order Information

Wireless Pressure Sensor .....PS-3203

Wireless Pressure Sensor Pack .....PS-3333

**Note:** Price for multi-sensor packs includes 8 sensors and custom storage case.

## Wireless Light and Color Sensor

PS-3248

The Wireless Light and Color Sensor features two separate apertures: One on the side of the box for ambient light measurements and one at the end of the box for directional light measurements for percent color.

### The ambient sensor measures:

**Lux:** Light energy from a point in a direction (per steradian, a solid angle) per second.

**Illuminance:** Light intensity per area, or brightness in the range our eyes perceive.

**Irradiance:** Power of the light per area. (Depends on wavelength as UV light has more energy than infra red).

**PAR (Photosynthetically Active Radiation):** Amount of light in the visible range 400 -700 nm available to stimulate plant growth.

**UV Index:** 1 to 12 scale for the time light takes to cause skin damage. Larger numbers cause burns faster.

### The spot sensor measures:

**RGB:** Light levels as a percent of the total of all colors measured

**White:** Total ‘white’ light intensity as a function of the sensor (on a scale of 65,536)



### Order Information

Wireless Light and Color Sensor .....PS-3248

Wireless Light Sensor Pack .....PS-3338

**Note:** Price for multi-sensor packs includes 8 sensors and custom storage case.

# Wireless Geiger Counter

PS-3238

The PASCO Wireless Geiger Counter counts beta, gamma and alpha radiation particles as they enter the Geiger-Müller detector tube inside the counter. Designed for easy mounting, the Geiger Counter provides superior position control in inverse square law labs, as well as an audible beep to indicate the detection of ionizing radiation. The front plastic snout fits conveniently inside the NU-3344 Sample Holder stand (available separately), which stabilizes the front of the counter's detector tube exactly 1 cm from the first slot in the holder.

With the Wireless Geiger Counter, students can wirelessly control the high voltage supplied to the Geiger-Müller tube inside the counter, enabling them to make measurements of counts per interval for different tube voltages. They can also create a plot of counts/interval versus tube voltages to experimentally observe the Geiger plateau characteristics of the tube.

### Features:

- Built-in metal mesh screen to protect the delicate mica window in the front of the Geiger-Müller detector tube
- Audible beep to indicate counts can be easily switched on or off
- **Versatile positioning options:** Use it with the NU-3344 Sample Holder, hand-held, or mount it to a rod stand
- Convenient design natively fits the PASCO NU-3344 Sample Holder
- Provides wireless control over the high voltage supplied to the Geiger-Müller tube inside the counter for Geiger plateau experiments

### Specifications:

**Sensitivity:** Alpha, Beta, Gamma

**Count Detection:** Switchable audio signal

**Gas Filling:** Ne +Halogen

**Effective Tube Diameter:** 9.1 mm

**Window Thickness:** 1.5 to 2.0 mg/cm<sup>2</sup>

**High Voltage Control Range:** 150 VDC to 650 VDC

**Standard Operating Voltage:** 500 VDC

### Includes:

- Wireless Geiger Counter
- Micro USB Cable: PS-3584
- Threaded handle for mounting the sensor to a ring stand

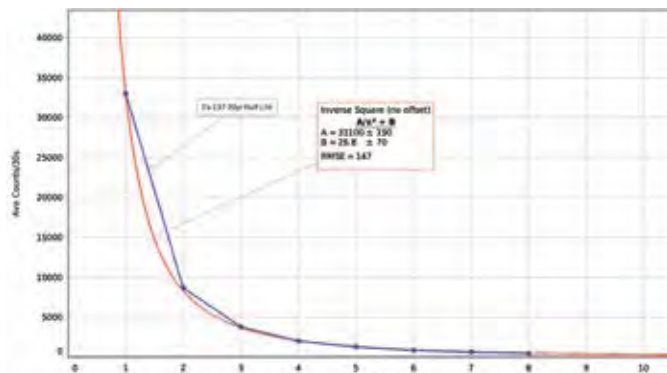

Measure counts/interval from a radioactive source at various distances to explore the inverse square law.

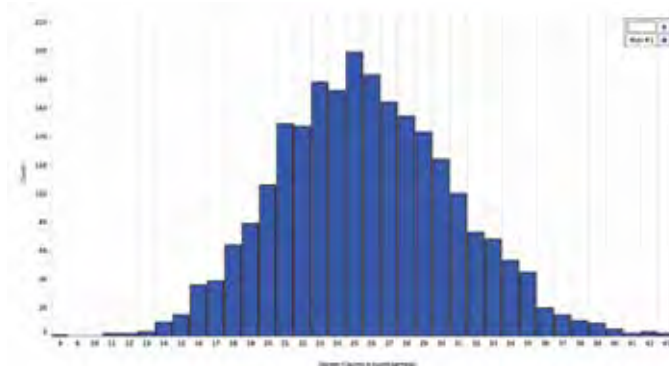

Demonstrate the statistical (gaussian or poisson) nature of counts/interval measured from a radioactive source with a long half-life.

Stabilize samples with the optional PASCO Geiger Counter Sample Holder.



### Order Information

Wireless Geiger Counter.....PS-3238  
 Geiger Counter Sample Holder .....NU-3344

## Wireless Temperature Sensor

PS-3201

Welcome to the modern thermometer. The Wireless Temperature Sensor transmits live data and allows students to continuously monitor, log, and plot temperature measurements on nearly any device. When lab-time ends but the experiment continues, students can set the sensor to log data autonomously for days, weeks, or months, then download it for analysis later. This durable, wireless sensor features a stainless steel probe for the most demanding of applications, as well as a battery that lasts over a year\*. It can be used in a wide array of experiments and activities because it measures small, but significant temperature changes produced by chemical reactions, convection currents, and even skin temperatures.



### Order Information

Wireless Temperature Sensor.....PS-3201

Wireless Temperature Sensor Pack.....PS-3330

**Note:** Price for multi-sensor packs includes 8 sensors and custom storage case.

## Wireless Current Sensor

PS-3212

The Wireless Current Sensor's broad current range supports a wide variety of experiments, ranging from basic circuit studies to advanced electricity labs. Designed with user safety in mind, the sensor can be used to measure currents up to 1 A and includes built-in overload protection. The collected data can be wirelessly transmitted to computers, Chromebooks, tablets, and smartphones. When paired with the Wireless Voltage Sensor, students can explore Ohm's Law, circuits in series and parallel, and much more.

## Wireless Voltage Sensor

PS-3211

The Wireless Voltage Sensor is ideal for exploring the fundamental concepts of electricity, voltage, and basic circuits. Complete with built-in overload protection, this sensor measures voltages up to  $\pm 15$  V and features high-speed sampling rates when connected via USB. When used with the Wireless Current Sensor, students can use it to explore Ohm's law, circuits in series and parallel, and much more.



### Order Information

Wireless Current Sensor .....PS-3212

Wireless Voltage Sensor.....PS-3211

**Note:** Multi-sensor packs with 8 sensors and custom storage case available on web.



## Wireless Force Acceleration Sensor

PS-3202

Capable of simultaneously measuring force, acceleration, and rotational velocity, this sensor is ideal for experiments involving rotating platforms, moving carts, spring oscillations, collisions, and impulse. The wireless design offers improved measurement accuracy by eliminating cords that affect data collection. Students can use the finger-holes for handheld applications, or mount it onto a cart or rod for more complex experiments.

### Teaching Advantage:

- Bluetooth® 5.2 simple, one touch in-app pairing
- Long-lasting rechargeable battery
- Zeroing is completed within the software for accurate taring
- Logging mode stores data for force, acceleration, and rotation directly on the sensor for long-term experiments
- Simultaneously measures force and acceleration
- Built-in 3-axis acceleration sensor measures acceleration in x, y, and z axes, and calculates resultant acceleration
- Built-in gyroscope measures rotation about x, y, and z axes

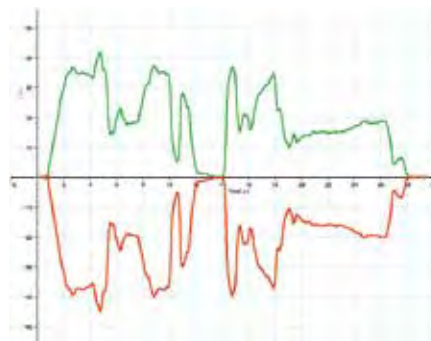

*The Wireless Force Acceleration Sensor is perfect for explorations of Newton's third Law.*



### Order Information

Wireless Force Acceleration Sensor.....PS-3202

Wireless Force Acceleration Sensor Pack.....PS-3339

**Note:** Price for multi-sensor packs includes 8 sensors and custom storage case.



## Wireless 1 & 2-Axis Force Platforms

PS-3229 & PS-3230

The Wireless Force Platforms build on the success of our PASPORT Force Platforms, offering users the same reliable performance with enhanced durability and a convenient, wireless connection.

The new design features a sturdy, glass-filled nylon platform and four supporting force beams that measure the forces acting normal to the platform's surface. The Wireless 2-Axis Force Platform also includes a fifth beam for measuring forces parallel to the platform. Along the bottom of each platform are four adjustable feet that make leveling quick and easy, while also ensuring stability between the force beams and the surface below. Students can measure the force applied to each beam independently or the overall resultant force acting on the surface of the platform (up to 5200 N). With their new wireless design, the Wireless Force Platforms are easier to use than ever, providing both spacial flexibility and custom sample rates for high speed sampling over Bluetooth® (up to 10 kHz).

### Features:

- Improved ruggedized design with increased maximum force range
- Mechanical force over-limit protection
- Wide top surface for jumping and standing
- Burst sampling option for high speed wireless data collection

### Specifications:

**1-Axis Range:** -1320 N to 5280 N (resultant)

**2-Axis Range:** -1320 N to 5280 N (resultant);  $\pm 1300$  N parallel force

**Surface Dimensions:** 35 cm x 35 cm

**Maximum Sample Rate:** 10 kHz

**Resolution:** 0.2 N

**1-Axis Force Over-Limit Protection:** -500 N to 2000 N per beam

**2-Axis Force Over-Limit Protection:** -500 N to 2000 N per vertical beam;  $\pm 2000$  N parallel beam

*The 2-Axis platform measures the normal and parallel forces acting on the platform simultaneously. Determine the static weight of a structure or person, measure forces associated with the impacts of falling objects, and determine the dynamic vertical and parallel forces that arise when moving or jumping.*



### Order Information

Wireless Force Platform .....	PS-3229
Wireless 2-Axis Force Platform .....	PS-3230
Handle Set, Force Platform.....	PS-2548

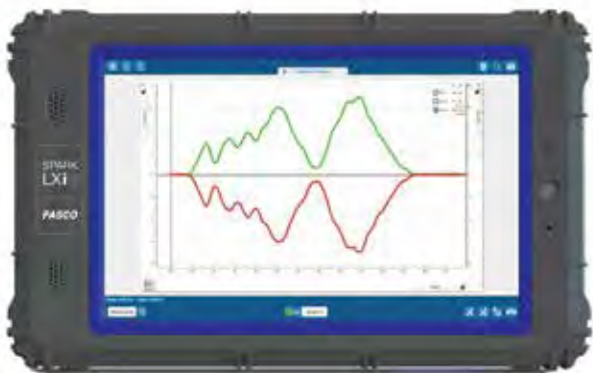

## SPARK LXi2 Datalogger

PS-3600B

The SPARK LXi2 Datalogger is a Bluetooth®, handheld datalogger that enables students to connect wired and wireless sensors, collect data, generate graphs, and analyze results. It is durable, splash-proof, and works seamlessly with PASCO sensors. The SPARK LXi2 can simultaneously accommodate up to five wireless sensors, includes two ports for PASPORT sensors, as well as two ports for the included Fast Response Temperature Probe and Voltage Probe. It can be used with PASCO Wireless sensors, PASPORT sensors and an AirLink, SPARKlink® Air, and the 550 Universal Interface.

### Built for Student Use:

- Portable
- Shock-absorbing case
- 8" Color Capacitive Touchscreen (1280 x 800 pixels)
- 2 GHz Quad Core Processor, 2.0 GB RAM, 32 GB Memory
- Voltage and temperature sensor ports with included probes
- Wi-Fi enabled
- Wireless sensors and Smart Carts connect via Bluetooth®
- Two PASPORT sensor ports
- **Loaded with PASCO software:** SPARKvue for data collection and analysis, MatchGraph!, and Spectrometry software



The SPARK LXi2 features two PASPORT ports as well as ports for the included temperature and voltage probes.



Scan to learn more about the SPARK LXi2



## 550 Universal Interface

UI-5001

The 550 Universal Interface is fast, powerful, and incredibly affordable. The cost-effective 550 offers half the ports and many of the same features as our 850 Universal Interface, including both Bluetooth® and USB connectivity. The 550 Universal Interface includes two PASPORT sensor ports, two digital sensor ports, two analog sensor ports, and a built-in signal generator.

The 550's two digital inputs are compatible with all ScienceWorkshop digital sensors, as well as timing devices, and photogates. The two analog ports connect with our analog ScienceWorkshop sensors and can support a 2.0 MHz max sampling rate and 1.22 mV resolution for voltage sensing.

The 550's built-in signal generator powers motors, speakers, circuits, and many other devices. With PASCO Capstone software and the 550, you can control various DC and AC waveforms, without requiring any other technology. The 550 provides 8 V at 400 mA, selectable voltage limits, built-in voltage and current measurements, and DC offset. Capstone software turns the 550 into a live oscilloscope that can display simultaneous traces.

Beyond having USB 2.0 connectivity, the 550 can also send data wirelessly to any Bluetooth® enabled computer, iPad, or Android tablet using PASCO Capstone or SPARKvue software.

### Features:

- USB and Bluetooth® connectivity
- 3.2 W power amplifier
- 2.0 MHz max sampling rate
- 100 kHz signal generator with built-in Voltage and Current sensors
- Compatible with PASPORT, ScienceWorkshop, and Wireless Sensors
- 2 high-speed analog inputs
- 2 digital inputs for photogates and other timing sensors
- 2 PASPORT sensor inputs
- Can be used simultaneously with other PASPORT interfaces
- Uses PASCO Capstone or SPARKvue Software



The 550 Universal Interface allows you to connect Science Workshop (analog), PASPORT (USB), and Wireless (Bluetooth®) sensors. It also includes a power amplifier and signal generator (not shown).

### Order Information

SPARK LXi2 Datalogger.....PS-3600B

### Order Information

550 Universal Interface.....UI-5001

# Interface Comparison

Compare the features and capabilities to see which interface is best for your lab.

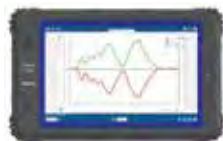

	SPARK LXi2 PS-3600B	AirLink PS-3200	SPARKlink Air PS-2011	550 Universal Interface UI-5001
PASPORT Ports	2	1	2	2
Analog Inputs	0	0	0	2 ( $\pm 10$ V, optional gain voltage 10x, 100x)
Digital Inputs	5	0	0	2
Connects via USB	Yes	Yes	Yes	Yes
Connects via Bluetooth®	Yes	Yes	Yes	Yes
Rechargeable Battery (for cordless operation only)	Yes	Yes	Yes	No (AC adapter)
Works with PASCO Capstone Software	No	Yes	Yes	Yes
Works with SPARKvue Software	Yes	Yes	Yes	Yes
Accepts PASPORT Sensors	Yes	Yes	Yes	Yes
Accepts ScienceWorkshop Sensors	No*	No*	No*	Yes
Maximum Sampling Rate	Sensor dependent <100 kHz	Sensor dependent <1000 Hz	Sensor dependent <1000 Hz	Up to 2 MHz on one channel
Signal Generator	N/A	N/A	N/A	$\pm 8$ V, at 400 mA, DC to 100 kHz
Included Items	Ruggedized case, hands-free stand, SPARKvue, MatchGraph!, Spectrometry	USB Cable	AC adapter, USB cable, fast response temperature and voltage probe	USB cable, Power supply

\* The AirLink and SPARKlink Air can accept most ScienceWorkshop sensors with the proper adapter, although they won't have the same high maximum sample rates. One exception is the Sound Sensor (UI-5101), which is not recommended for use with an adapter.

## AirLink Interface

PS-3200

The AirLink connects PASPORT sensors to a Mac® or Windows® computer, Chromebook, iPad, tablet, or smartphone via Bluetooth® or USB connection. The USB cable is included.



## SPARKlink Air Interface

PS-2011

The SPARKlink® Air allows students and teachers to connect any of our 70+ PASPORT sensors to their device via USB or Bluetooth®.



### Order Information

AirLink Interface .....PS-3200

### Order Information

SPARKlink Air Interface .....PS-2011

# Make the switch to **PASCO** capstone™ 2

## The Most Advanced Data Collection Software in Science Education

PASCO is pushing the limits of technology, so you can push your students to their potential. Working closely with educators, we continuously develop Capstone, making improvements and enhancing the teaching features. Capstone is designed to handle large data sets, high-speed sampling, and customized preferences to fit the needs of your lab. The straightforward user interface is approachable for beginners, yet Capstone offers all the capabilities needed for even the most advanced users.

### Features in PASCO Capstone 2

Visit [pasco.com/capstone](http://pasco.com/capstone) for more information.

### Circuits Emulation

Reinforce circuit concepts and tackle student misconceptions using circuit visualization.

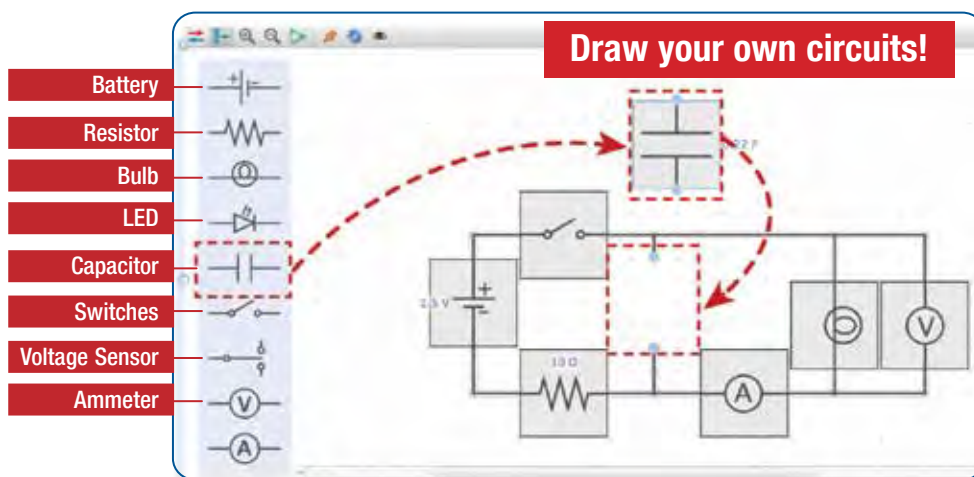

Combine real-world circuits with simulations, animations, and live measurements.

With this tool you can:

- Construct and modify circuits
- Show conventional current and electron flow animations
- Animate circuits with live sensor data
- Build your own circuits in Capstone, drag and drop components, and draw wires to connect them
- Demonstrate series and parallel
- Charge and discharge capacitors

### Examples of other circuit emulations

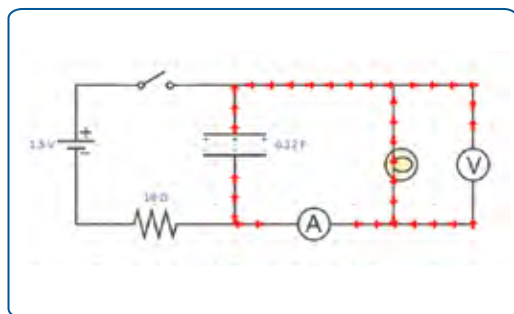

- Animate conventional current flow
- Animate a capacitor—charge or discharge
- Edit capacitor values

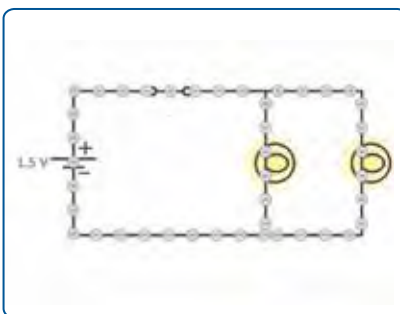

- Animate electron flow
- Connect components in parallel or series

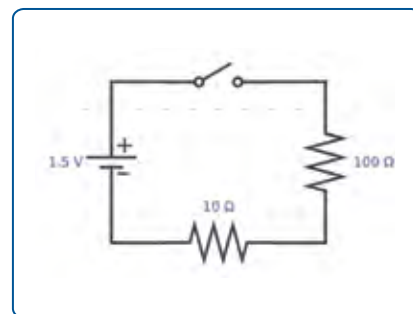

- Operate switches
- Edit voltage and resistor values



# Blockly Block-based Coding

- Control all PASCO sensors and interfaces
- Create sense and control programs
- Control outputs from sensor inputs

Bring computational thinking into your science lab!

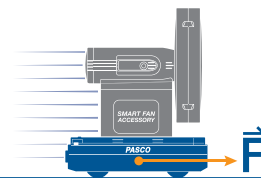

```

Write output voltage Smart Fan Accessory = 0
Sleep in ms 100
set k to -110
set b to 160
set Xo to 0.3
set N to 0
repeat 10000 times
do
change N by 1
set x to Read Measurement Position, Blue m
set v to Read Measurement Velocity, Blue m/s
set P to k * x - Xo - b * v
Write output voltage Smart Fan Accessory = P
Write numeric to UED power = P
Sleep in ms 20
if absolute v > 0.1 and N < 100
do
set Xo to -1 * x - Xo
set N to 0
Write output voltage Smart Fan Accessory = 0
    
```

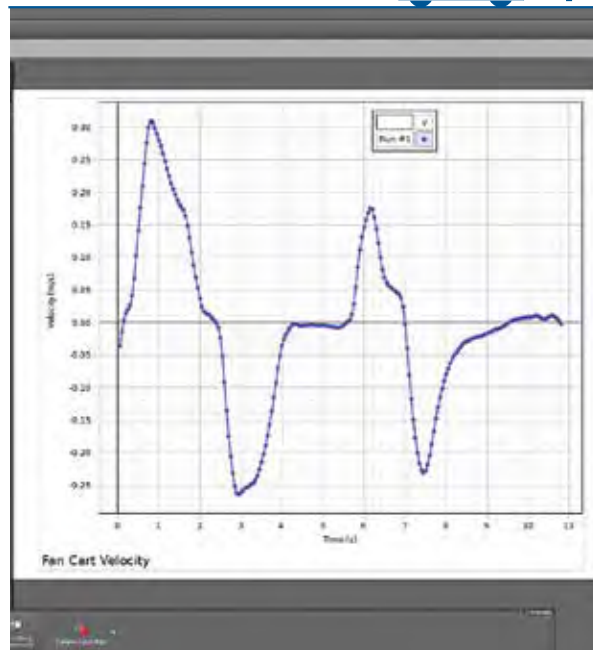

## Graph Pop-up Tools

Quick access to commonly used analysis tools

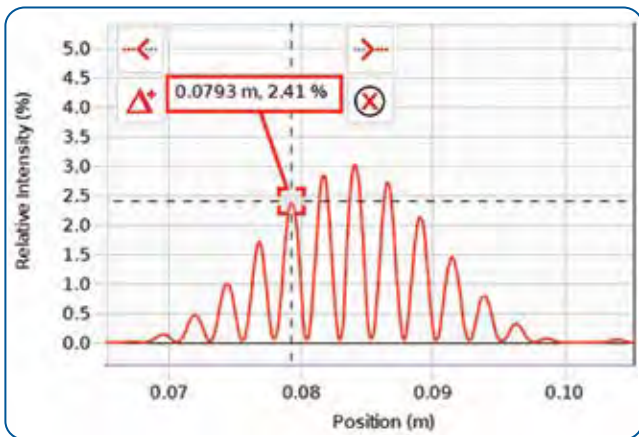

Visit [pasco.com/capstone](http://pasco.com/capstone) for more information.

Capstone has all the software tools you need for data collection and analysis. And we continue to add more features, based on input from physics educators just like you!

- Exclude or delete selected data points from analysis
- Create models using the calculator
- Calculated columns in tables
- Error bars
- Weighted linear fit that takes error bars into account
- More complex curve fits such as damped sine, Gaussian, sine series, and user-entered fits
- Smooth data directly on a graph with slider tool
- Global preferences settings

### Order Information

PASCO Capstone  
 Site License ..... UI-5400 or UI-5400-DIG

Download the Free Trial  
[www.pasco.com/Capstone](http://www.pasco.com/Capstone)



## TOOLS



### Configure PASCO Hardware

Works with PASPORT, ScienceWorkshop, and Wireless Sensors



### Photogate Timer Wizard

Easily configure photogates and timing measurements



### Data Summary

- Equations/calculations
- Fundamental constants
- Experimental constants
- Trials and runs



### Sensor Calibration Wizard

- Step by step calibration
- Many calibration types



### Signal Generator

- Scan through a range of frequencies
- Control signal output with a calculation



### Calculator

- Graph modeling
- Create data sets using sensor data

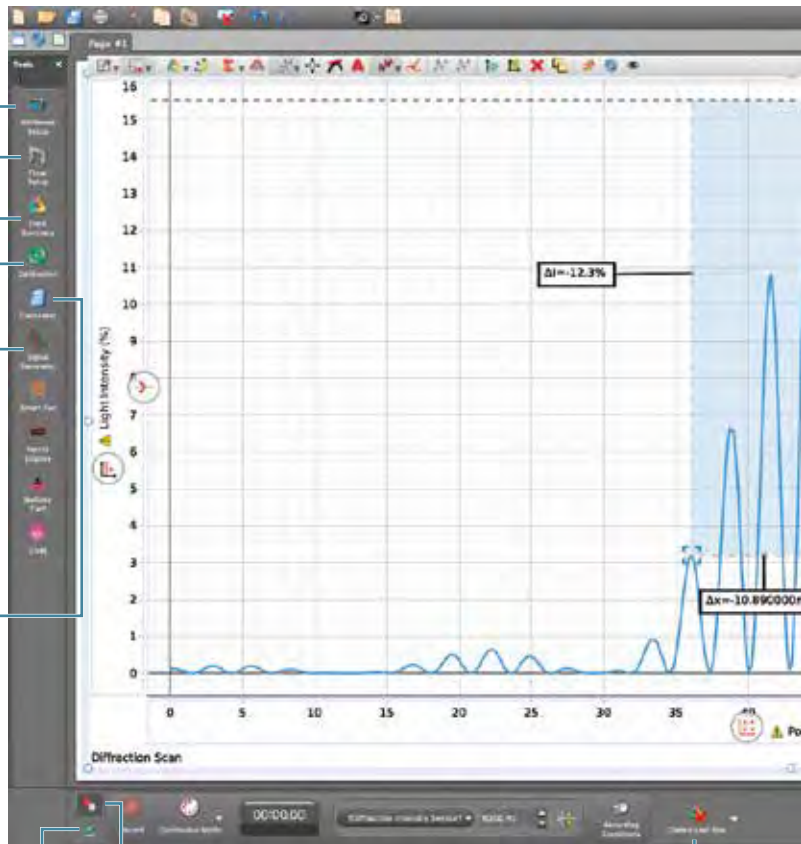

### Replay Your Data

- Change replay rate
- Increment by frame
- Loop playback



### Sampling Options

- Continuous manual sampling
- Fast monitor mode
- Independent sensor sampling rates
- Start/stop conditions
- Zero sensor

## Capstone 2 Includes Video Analysis

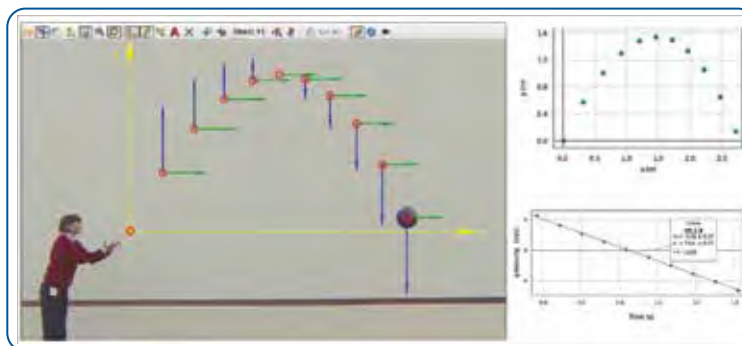

Sophisticated scientific calculator has statistics, calculus, filters, logic functions, and special operations such as amplitude and period.

Import video and analyze the motion of objects to measure position, velocity, and acceleration. With this tool you can also:

- Show velocity and acceleration vectors
- Use magnifier to identify exact center of an object
- Use calibration ruler at any time
- And so much more!

PASCO's  
proximity in-app  
sensor pairing:  
U.S. Patent  
Number  
10,356,594

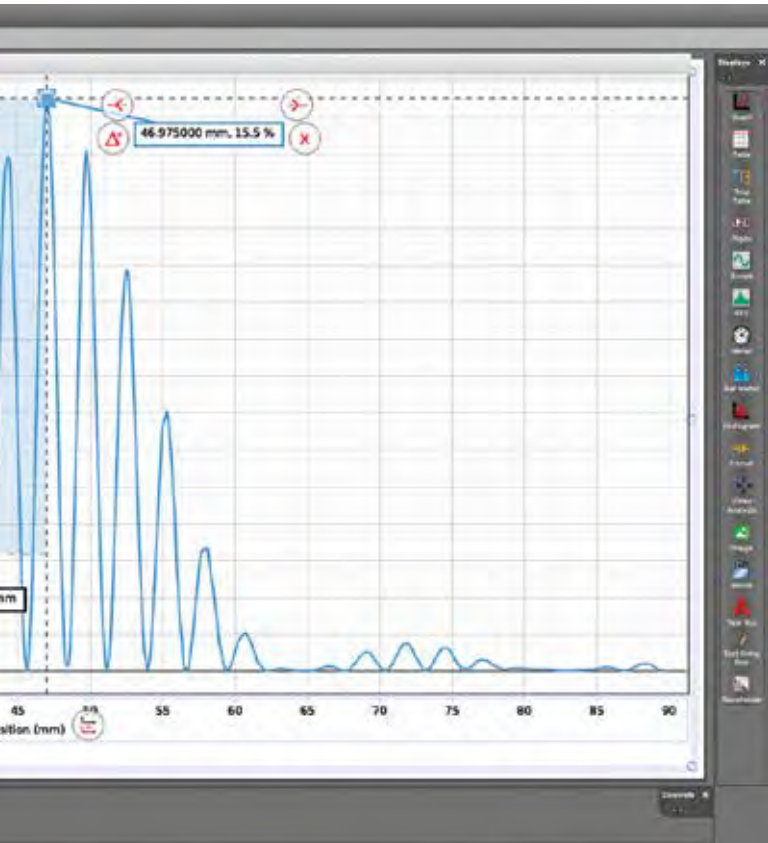

## DISPLAYS

### Display Your Data Your Way

- Graph
- Table
- Digits
- Scope
- FFT
- Meters

### Graph Tools Include

- Draw predictions on graphs before taking data
- Multiple y-axes and/or multiple plot areas
- Perform Quick-Calcs on the graph axis to linearize data
- Curve-fits report the uncertainties in the parameters
- Multi-coordinate tool gives y-values wherever it intersects data

### Error Bars and Weighted Linear Fits

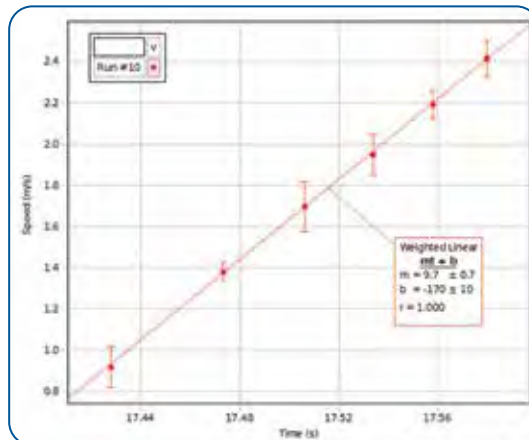

Graph uncertainties using user-entered error bars, absolute error, or percent error. The weighted linear fit incorporates the error bars.

Visit [pasco.com/capstone](http://pasco.com/capstone) for more information.



### Delete Runs

- Last run only
- Select from list
- All runs

Made a mistake?



Just hit  
**UNDO**

### Oscilloscope Display

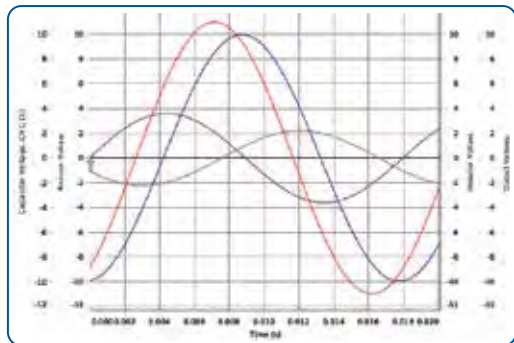

This display behaves like an authentic digital oscilloscope.

- Trigger
- Single trace collection
- Sample rate tied to time axis scale
- Set trace offset

### FFT

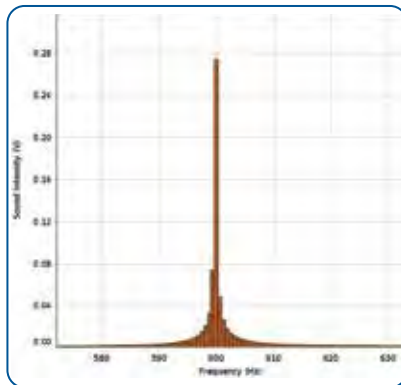

Display data in the frequency domain to find peak frequency and harmonics.

- Sample rate tied to axis scale
- Normalize data
- Adjust BIN width

### Multi-Coordinate Tool

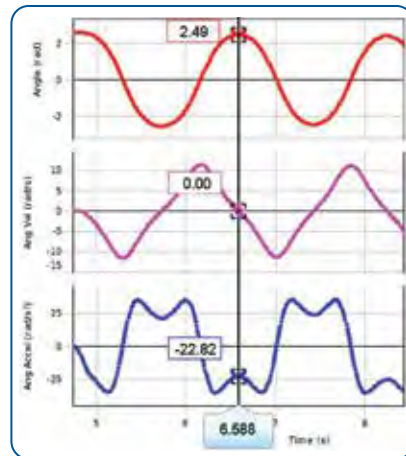

Easily show the relationship between multiple data plots by comparing data values across the time axis.

## Sensor Index

WIRELESS SENSORS	Part Number	Page Number
Acceleration/Altimeter .....	PS-3223 .....	114
Blood Pressure .....	PS-3218 .....	114
CO <sub>2</sub> .....	PS-3208 .....	115
//code.Node .....	PS-3231 .....	115
Colorimeter & Turbidity .....	PS-3215 .....	115
Conductivity .....	PS-3210 .....	115
//control.Node .....	PS-3232 .....	116
Current .....	PS-3212 .....	116
Drop Counter .....	PS-3214 .....	116
EKG .....	PS-3236 .....	116
Exercise Heart Rate .....	PS-3207 .....	116
Force Platforms 2D .....	PS-3229 .....	116
Force Platform 1D .....	PS-3230 .....	117
Force Acceleration .....	PS-3202 .....	117
Geiger Counter .....	PS-3238 .....	117
Greenhouse .....	PS-3322 .....	117
Hand-Grip Heart Rate .....	PS-3206 .....	118
Light & Color .....	PS-3213 .....	118
Load Cell Accelerometer .....	PS-3216 .....	118
Melting Point Apparatus .....	PS-3246 .....	118
Magnetic Field 3-Axis .....	PS-3221 .....	118
Motion .....	PS-3219 .....	118
Optical Dissolved O <sub>2</sub> .....	PS-3224 .....	119
O <sub>2</sub> Gas .....	PS-3217 .....	119
pH .....	PS-3204 .....	119
Polarimeter .....	PS-3237 .....	119
Pressure .....	PS-3203 .....	119
Rotary Motion .....	PS-3220 .....	120
Smart Gate .....	PS-3225 .....	120
Smart Cart (red) .....	ME-1240 .....	120
Smart Cart (blue) .....	ME-1241 .....	120
Soil Moisture .....	PS-3228 .....	121
Sound .....	PS-3227 .....	121
Spectrometer .....	PS-2600 .....	121
Spirometer .....	PS-2600 .....	121
Temperature .....	PS-3222 .....	121
Temperature Link .....	PS-3201 .....	121
Voltage .....	PS-3211 .....	122
Weather with GPS .....	PS-3209 .....	122

### Classroom Sensor Multi-Packs

The Wireless Sensor Packs contain 8 Wireless Sensors inside a Grathells storage tray. Also inside the tray is a custom insert designed to securely fit each sensor. The trays provide a convenient and well-ordered storage solution for any classroom, while also making transportation between classrooms effortless.



Look for this symbol on sensors available in multi-packs

### Wireless Acceleration/Altimeter

PS-3223

#### Specifications:

##### Low-g Accelerometer:

**Range:** ±16 g

**Resolution:** 0.002 g at 20 Hz

**Accuracy:** ±0.04 g

**Maximum Sample Rate:** 5 kHz

##### High-g Accelerometer:

**Ranges:** ±100 g, ±200 g, ±400 g

**Resolution:** 0.04 g (@ ±100 g) at 20 Hz

**Accuracy:** ±1 g (@ ±100 g)

**Maximum Sample Rate:** 5 kHz

##### Altimeter:

**Range:** -1.8 km to 9.5 km

**Resolution:** 10 cm

**Maximum Sample Rate:** 200 Hz

##### Gyroscope:

**Range:** ±34.9 rad/s

**Accuracy:** ±0.02 rad/s

**Maximum Sample Rate:** 1 kHz

**Connectivity:** Bluetooth 5.2

**Logging:** Yes

**Battery Type:** Coin Cell



#### Order Information

Wireless Acceleration/Altimeter.....PS-3223

### Wireless Blood Pressure Sensor - Standard Cuff

PS-3218

#### Specifications:

##### Heart Rate

**Range:** 36 to 200 bpm

**Resolution:** 1 bpm

**Accuracy:** ±1 bpm

##### Blood Pressure

**Range:** 0 to 260 mmHg

**Resolution:** 0.05 mmHg

**Accuracy:** ±3 mmHg

##### Gauge Pressure

**Range:** 0 to 260 mmHg

**Resolution:** 0.05 mmHg

**Accuracy:** ±3 mmHg

**Connectivity:** USB and Bluetooth 5.2

**Logging:** No

**Battery Type:** Rechargeable LiPo



#### Order Information

Wireless Blood Pressure Sensor with Standard Cuff..... PS-3218

## Wireless CO<sub>2</sub> Sensor (Carbon Dioxide)

PS-3208

### Specifications:

**Range:** 0 to 100,000 ppm

**Resolution:** 2 ppm

**Accuracy:** 1,000 – 10,000 ppm Range: ±5% of reading + 100ppm, 10,000 – 50,000 ppm Range: ±10% of reading, 50,000 – 100,000 ppm Range: ±15% of reading

**Warm-up Time:** 3 min

**Response Time:** 90% in 30 sec

**Operating Temperature Range:** -10°C–50°C (5°C to 30°C ideal for LiPo charging)

**Metabolism Bottle Volume:** 250 mL

**Metabolism Bottle Care:** Warm soapy water (not boiling)

**Connectivity:** USB and Bluetooth 5.2

**Logging:** Yes

**Battery Type:** Rechargeable LiPo



Wireless CO<sub>2</sub> Sensor (Carbon Dioxide) .....PS-3208

## Wireless Colorimeter & Turbidity Sensor

PS-3215

### Specifications:

**Color Detection/Peak Wavelengths:** 650 nm (red), 600 nm (orange), 570 nm (yellow), 550 nm (green), 500 nm (blue), 450 nm (violet)

**Detection Wavelength Range:** ±25 nm from peak

**Absorbance:** 0–3 Abs units; useful range (0.05–1.5 Abs)

**Transmittance:** 0-100%

**Turbidity Illumination Wavelength:** 850 nm

**Turbidity Range:** 0-400 NTU

**Accuracy:** ±5% NTU

**Connectivity:** USB and Bluetooth 5.2

**Logging:** Yes

**Battery Type:** Rechargeable LiPo

### Order Information

Wireless Colorimeter & Turbidity Sensor .....PS-3215

## //code.Node

PS-3231

### Specifications:

**Light Level Sensor Range:** 600 lx to 50,000 lx (not calibrated)

**Sound Level Sensor Range:** 70 to 100 dB (not calibrated)

**Magnetic Field Sensor Range:** ±50 gauss

**Acceleration Sensor Range:** ±8 g

### Ambient Temperature

**Range:** -25°C to 40°C

**Resolution:** 0.05°C

**Accuracy:** ±1°C

### Speaker Frequency Range:

10 Hz to 10,000 Hz

**Maximum Sample Rate:** 100 Hz

**Connectivity:** USB and Bluetooth 5.2

**Logging:** No

**Battery Type:** Rechargeable LiPo



## Wireless Conductivity Sensor

PS-3210A

### Specifications:

**Range:** 0 to 40,000 µS/cm (0 to 28,000 mg/L TDS)

**Resolution:** 0.1 µS/cm

**Accuracy (200 - 40,000):** ±5% of value

**Accuracy (below 200):** ±25 %

### Total Dissolved Solids:

**Range:** 0 to 30,000 ppm

**Resolution:** 0.1 ppm

**Accuracy:** 10% between 100–30,000 ppm

**Response Time:** 95% of in 5 seconds

**Environmental Tolerance:** 0 to 80°C

**Temperature Compensation:** 0 to 35°C

**Temperature Accuracy:** ±0.5°C

**Waterproof:** IPX7 rated (1 meter for 30 min)

**Connectivity:** Bluetooth 5.2

**Logging:** Yes

**Battery Type:** Coin Cell

### Order Information

//code.Node .....PS-3231

### Order Information

Wireless Conductivity Sensor .....PS-3210A

## //control.Node

PS-3232

### Specifications:

#### Power Output Ports:

±5 VDC, 0.7 A

Auto-ID stepper motors and Power Output Module

8-pin modular jack

**Product Servo Ports:** Accepts standard servos and continuous rotation servos, 3-pin connector, Built-in servo current sensor for detecting load, and I2C

**Sensor Port:** 6-pin modular jack

**Acceleration Sensor:** ±16g, 3-axis

**Speaker Frequency Range:** 10 Hz to 10,000 Hz

**Connectivity:** USB and Bluetooth 5.2

**Logging:** No

**Battery Type:** Rechargeable LiPo

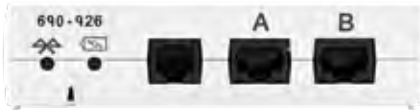

## Wireless EKG Sensor

PS-3236

### Specifications:

**Voltage Range:** 0 to 4.5 mV

**Voltage Resolution:** 5  $\mu$ V

**Default Sample Rate:** 250 Hz

**Maximum Sample Rate:** 1000 Hz

**Heart Rate Range:** 40 to 250 bpm

**Accuracy:** ±1 bpm

**Connectivity:** USB and Bluetooth 5.2

**Battery Type:** Rechargeable LiPo

**Logging:** Yes



### Order Information

Wireless EKG Sensor.....PS-3236

## Wireless Exercise Heart Rate Sensor

PS-3207

### Specifications:

**Approximate mass, strap and connector:** 40 grams

**Sensor Range:** 0 to 240 beats per minute

**Accuracy:** ±1 beat per minute

**Resolution:** 1 bpm

**Maximum Sample Rate:** Every two seconds

**Default Sample Rate:** Every five seconds

**Connectivity:** USB and Bluetooth 5.2

**Logging:** No

**Battery:** Coin Cell



### Order Information

Wireless Exercise Heart Rate Sensor.....PS-3207

## Wireless Current Sensor

PS-3212

### Specifications:

#### High Current:

**Range:** ±1 A

**Resolution:** 0.2 mA

#### Low Current:

**Range:** ±0.1 A

**Resolution:** 0.02mA

**Input Resistance:** 0.1  $\Omega$

**Maximum Sample Rate:** 100 kHz

**Connectivity:** USB or Bluetooth 5.2

**Logging:** Yes

**Battery Type:** Rechargeable LiPo



## Wireless 2-Axis Force Platform

PS-3230

### Specifications:

**Force Range:** -1320 N to 5280 N (resultant)

**Parallel Force Range:** ±1,300 N

**Resolution:** 0.2 N

**Maximum Sample Rate:** 10 kHz

**Force Over-Limit Protection:** -500 N to 2000 N per vertical beam; ±2,000 N parallel beam

**Dimensions:** 35 x 35 x 7.1 cm

**Connectivity:** USB and Bluetooth 5.2

**Logging:** No

**Battery Type:**  
Rechargeable LiPo

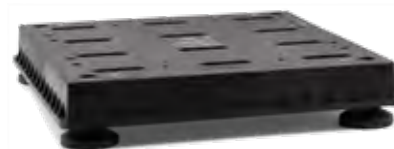

## Wireless Drop Counter

PS-3214

### Specifications:

**Range:** 0 to 40 drops/second

**Accuracy:** ±1 drop

**Resolution:** 1 drop

**Optical Window:** Acrylic

**Connectivity:** USB and Bluetooth 5.2

**Logging:** No

**Battery Type:** Rechargeable LiPo



### Order Information

Wireless 2-Axis Force Platform.....PS-3230

### Order Information

Wireless Drop Counter.....PS-3214

## Wireless Force Platform

PS-3229

### Specifications:

- Range:** -1320 to 5280 N (resultant)
- Resolution:** 0.2 N
- Maximum Sample Rate:** 10 kHz
- Surface Dimensions:** 35 x 35 cm
- Force Over-Limit Protection:** -500 to 2000 N per beam
- Connectivity:** USB and Bluetooth 5.2
- Logging:** No
- Battery Type:** Rechargeable LiPo



### Order Information

Wireless Force Platform .....PS-3229

## Wireless Force Acceleration Sensor

PS-3202

### Specifications:

- Force Sensor:**
- Range:**  $\pm 50$  N
- Resolution:** 0.03 N
- Accuracy:** 0.1 N
- Maximum Sample Rate:** 1000 Hz
- Accelerometer:**
- Range:**  $\pm 16$  g
- Accuracy:**  $\pm 0.2$  m/s<sup>2</sup> (at 9.8 m/s<sup>2</sup>)
- Maximum Sample Rate:** 500 Hz
- Gyro Sensor:**
- Range:**  $\pm 2000$  °s
- Maximum Sample Rate:** 500 Hz
- Connectivity:** USB and Bluetooth 5.2
- Logging:** Yes
- Battery Type:** Rechargeable LiPo



### Order Information

Wireless Force Acceleration Sensor ..... PS-3202

## Wireless Geiger Counter

PS-3238



### Specifications:

- Sensitivity:** Alpha, Beta, Gamma
- Count Detection:** Switchable audio signal
- Gas Filling:** Ne +Halogen
- Effective Tube Diameter:** 9.1 mm
- Window Thickness:** 1.5 to 2.0 mg/cm<sup>2</sup>
- High Voltage Control Range:** 150 VDC to 650 VDC
- Standard Operating Voltage:** 500 VDC
- Connectivity:** USB and Bluetooth 5.2
- Logging:** Yes
- Battery:** Rechargeable LiPo

### Order Information

Wireless Geiger Counter.....PS-3238

## Greenhouse Sensor

PS-3322

### Specifications:

- Operating Temperature:** -40°C to 80°C
- Light Level Sensor:**
- Wavelength Range:** Visible Spectrum (400 nm to 700 nm)
- Sensitivity Range:** Approximately 600 lx to 50,000 lx (not calibrated)
- Resolution:** 0.1%
- Accuracy:** 5%
- Report out:** 0 to 100% of max reading
- Ambient Temperature:**
- Range:** -40°C to 80°C
- Resolution:** 0.01°C
- Accuracy:**  $\pm 0.5$ °C
- Humidity Sensor:**
- Range:** 0 to 95% non condensing
- Resolution:**  $\pm 0.02$ %
- Accuracy:**  $\pm 3$ %
- Temp, Light, Humidity Sensors:**
- Power Use:** 0.98 mA at 3.3 V DC
- Soil Moisture Sensor:**
- Range:** 0 to 45%
- Resolution:** 0.1%
- Accuracy:**  $\pm 5$ %
- Probe Cable Length:** 2 m
- Connectivity:** USB and Bluetooth 5.2
- Logging:** No
- Battery Type:** Coin Cell



### Order Information

Greenhouse Sensor.....PS-3322

## Wireless Hand-Grip Heart Rate Sensor

PS-3206

### Specifications:

**Range:** 0 to 240 bpm

**Resolution:** 1 beat

**Accuracy:**  $\pm 1$  bpm

**Maximum Sample Rate:** Every two seconds

**Default Sample Rate:** Every five seconds

**Connectivity:** Bluetooth 5.2

**Logging:** No

**Battery:** Coin Cell



### Order Information

Wireless Hand-Grip Heart Rate Sensor .....PS-3206

## Wireless Light & Color Sensor

PS-3248



### Specifications:

**Spectral Response:** 340 nm to 1150 nm

**Illuminance Range:** 0 to 131,000 lux

**Irradiance Range:** 0 to 1362 W/m<sup>2</sup>

**PAR Range:** 0 to 2400  $\mu\text{mol}/\text{m}^2/\text{s}$

**UV Index Range:** 0 to 12 (typical in daylight)

**RGB Range:** 0 to 100% of clear LED response

**Maximum Sample Rate:** 2 Hz (ambient); 20 Hz (spot)

**Connectivity:** USB and Bluetooth 5.2

**Logging:** Yes

**Battery Type:** Coin Cell



### Order Information

Wireless Light and Color Sensor .....PS-3248

## Wireless Load Cell and Accelerometer

PS-3216

### Specifications:

**Force Sensor:**

**Range:**  $\pm 50$  N

**Resolution:** 0.03 N

**Accuracy:**  $\pm 0.1$  N

**Maximum Sample Rate:** 2 kHz

**Accelerometer:**

**Range:**  $\pm 16$  g (three-axis)

**Maximum Sample Rate:** 500 Hz

**Connectivity:** USB and Bluetooth 5.2

**Logging:** Yes

**Battery Type:** Rechargeable LiPo



### Order Information

Wireless Load Cell and Accelerometer .....PS-3216

## Wireless Magnetic Field Sensor

PS-3221

### Specifications:

**High Magnetic Field:**

**Range:**  $\pm 1300$  G

**Resolution:**  $\pm 1$  G

**Low Magnetic Field:**

**Range:**  $\pm 50$  G

**Resolution:**  $\pm 0.01$  G

**Maximum Sample Rate:** 100 Hz

**Connectivity:** USB and Bluetooth 5.2

**Logging:** Yes

**Battery Type:** Rechargeable LiPo



### Order Information

Wireless Magnetic Field Sensor .....PS-3221

## Melting Point Apparatus

PS-3239



### Specifications:

**Temperature:**

**Range:** 0 to 380 °C

**Accuracy:** 1.0 °C out of box, 0.1 °C if calibrated

**Maximum Sample Rate:** 1 Hz

**Viewing Lens:** 3x

**Connectivity:** Bluetooth 5.2 (for temperature data)

**Camera (sold separately) Connectivity:** USB

**Logging:** No

**Battery:** No



### Order Information

Melting Point Apparatus .....PS-3239

## Wireless Motion Sensor

PS-3219

### Specifications:

**Range:** 0.15 to 4 m

**Resolution:** 1 mm

**Maximum Sample Rate:** 250 Hz

**Transducer Rotation Range:** 180°

**Connectivity:** USB and Bluetooth 5.2

**Logging:** No

**Battery Type:** Rechargeable LiPo



### Order Information

Wireless Motion Sensor .....PS-3219



## Wireless Optical Dissolved Oxygen Sensor

PS-3246

**Specifications:**

**Range:** 0 to 20 mg/L, 0 to 300% saturation

**Resolution:** 0.01 mg/L

**Accuracy (with calibration):** ±0.2 mg/L or 1% (whichever is greater)

**Accuracy (out of the box):** ±0.5 mg/L or 3% (whichever is greater)

**Response Time:** 90% in 20 sec

**Measurements:** Concentration (mg/L), Saturation (%), O<sub>2</sub> Gas (in air, qualitative) (%), Temperature (°C)

**Waterproof Depth (probe):** 2.5 m

**Cable Length:** 3.0 m

**Connectivity:** USB and Bluetooth 5.2

**Logging:** Yes

**Battery Type:** Rechargeable LiPo

**NEW**



**Order Information**

Wireless Optical Dissolved Oxygen Sensor (NEW!)PS-3246

## Wireless Oxygen Gas Sensor

PS-3217

**Specifications:**

**Range:** 0–100% O<sub>2</sub> concentration; 0–1,000,000 ppm

**Resolution:** 0.01% oxygen

**Accuracy:** ±1% O<sub>2</sub> at constant temperature and pressure; ±5% O<sub>2</sub> outside operating range

**Operating Temperature Range:** 0–40°C

**Relative Humidity Range:** 0–100% (non-condensing)

**Sensing Element Lifespan:** 2+ years

**Pressure Range:** 0.7 - 1.3 atm

**Connectivity:** USB and Bluetooth 5.2

**Logging:** Yes

**Battery Type:** Rechargeable LiPo



**Order Information**

Wireless Oxygen Gas Sensor.....PS-3217

## Wireless pH Sensor

PS-3204

**Specifications:**

**Range:** 0-14 pH

**Resolution:** 0.02 pH

**Accuracy:** ±0.1 pH with calibration

**Temperature Range:** 5°C to 60°C

**Connectivity:** USB and Bluetooth 5.2

**Logging:** Yes

**Battery Type:** Coin Cell



**Order Information**

Wireless pH Sensor.....PS-3204

## Wireless Polarimeter

PS-3237

**Specifications:**

**Optical Rotation Accuracy:** ±0.09°

**Cell Length (horizontal):** 101 mm ± 0.6 mm

**Connectivity:** USB and Bluetooth 5.2

**Logging:** No

**Battery Type:** Rechargeable LiPo



**Order Information**

Wireless Polarimeter .....PS-3237

## Wireless Pressure Sensor

PS-3203

**Specifications:**

**Range:** 0-400 kPa

**Resolution:** 0.1 kPa

**Accuracy:** ±2 kPa

**Max Sample Rate:** 1000 Hz

**Connectivity:** USB and Bluetooth 5.2

**Logging:** Yes

**Battery Type:** Rechargeable LiPo

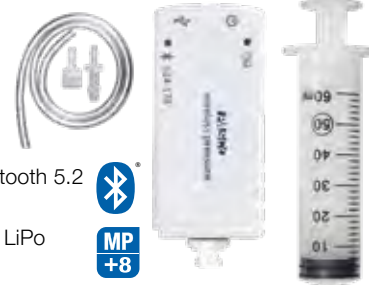

**Order Information**

Wireless Pressure Sensor .....PS-3203

## Wireless Rotary Motion Sensor

PS-3220

### Specifications:

- Angular Resolution:** 0.18° (0.00314 radian)
- Linear Resolution:** 0.0157 mm (with 10 nm pulley radius)
- Three-Step Pulley:** 10, 29, and 48 mm diameter
- Shaft Diameter:** 6.35 mm
- Maximum Rotation Rate:** 30 revolutions per second
- Optical Encoder:** 2000 divisions/rev, bidirectional
- Connectivity:** USB or Bluetooth 5.2
- Logging:** Yes
- Battery Type:** Rechargeable LiPo



### Order Information

Wireless Rotary Motion Sensor .....PS-3220

## Wireless Smart Gate

PS-3225

### Specifications:

- Gate Separation:** 1.5 cm
- Timing Resolution:** 3 ms
- Minimum Block Time:** 1.5 ms
- Beam Wavelength:** 940 nm
- Gate Inside Width:** 7.2 cm
- Connectivity:** USB and Bluetooth 5.2
- Logging:** No
- Battery Type:** Rechargeable LiPo



### Order Information

Wireless Smart Gate .....PS-3225

## Smart Cart Charging Garage

ME-1243

Charge up to five Smart Carts at once. Provides storage for the carts and accessory bumpers. Includes power adapter.



### Order Information

Smart Cart Charging Garage .....ME-1243

## Smart Cart (Red)

ME-1240

### Specifications:

- Optical Encoder:**
- Range:** ±3.0 m/s
- Resolution:** ±0.2 mm
- Maximum Sample Rate:** 500 Hz
- Accelerometer:** Range: ±16 g
- Accuracy:** ± 0.2 m/s<sup>2</sup> at 9.8 m/s<sup>2</sup>
- Maximum Sample Rate:** 500 Hz
- Force Sensor:**
- Range:** ±100 N
- Resolution:** 0.1 N
- Accuracy:** ±1.0%
- Maximum Sample Rate:** 2 kHz
- Gyro Sensor:**
- Range:** ±245 °/s
- Maximum Sample Rate:** 500 Hz
- Patent No.:** 10481173
- Connectivity:** USB and Bluetooth 5.2
- Logging:** No
- Battery Type:** Rechargeable LiPo



### Order Information

Smart Cart (Red) .....ME-1240

## Smart Cart (Blue)

ME-1241

### Specifications:

- Optical Encoder:**
- Range:** ±3.0 m/s
- Resolution:** ±0.2 mm
- Maximum Sample Rate:** 500 Hz
- Accelerometer:** Range: ±16 g
- Accuracy:** ± 0.2 m/s<sup>2</sup> at 9.8 m/s<sup>2</sup>
- Maximum Sample Rate:** 500 Hz
- Force Sensor:**
- Range:** ±100 N
- Resolution:** 0.1 N
- Accuracy:** ±1.0%
- Maximum Sample Rate:** 2 kHz
- Gyro Sensor:**
- Range:** ±245 °/s
- Maximum Sample Rate:** 500 Hz
- Patent No.:** 10481173
- Connectivity:** USB and Bluetooth 5.2
- Logging:** No
- Battery Type:** Rechargeable LiPo



### Order Information

Smart Cart (Blue) .....ME-1241

## Wireless Soil Moisture Sensor

PS-3228

### Specifications:

- Range:** 0 to 45% water by volume
- Accuracy:** ±5% water by volume
- Resolution:** 0.1%
- Power:** 3 mA at 5 VDC
- Operating Temperatures:** -40 to 60°C
- Probe Cable Length:** 2 m
- Connectivity:** USB and Bluetooth 5.2
- Logging:** Yes
- Battery Type:** Rechargeable LiPo



### Order Information

Wireless Soil Moisture Sensor .....PS-3228

## Wireless Sound Sensor

PS-3227

### Specifications:

- Microphone Frequency Range:** 100 to 20,000 Hz
- Sound Wave Maximum Sample Rate:** 100 kHz
- Sound Level Range:** 50 to 110 dB
- Accuracy:** ±2 dB
- Response:** A or C weighted
- Connectivity:** USB and Bluetooth 5.2
- Logging:** Yes
- Battery Type:** Rechargeable LiPo



### Order Information

Wireless Sound Sensor .....PS-3227

## Wireless Spectrometer (VIS)

PS-2600

### Specifications:

- Resolution:** 2nm to 3nm FWHM
- Detection Range:** 380–950 nm
- Fluorescence Excitation Wavelengths:** 405 nm and 500 nm
- Light Source:** LED-boosted tungsten
- Connectivity:** USB and Bluetooth 5.2
- Logging:** No
- Battery Type:** Rechargeable LiPo



### Order Information

Wireless Spectrometer (Vis) .....PS-2600A

## Wireless Spirometer

PS-3234

### Specifications:

- Maximum Sample Rate:** 1 kHz
- Maximum Flow Rate:** ±14 L/s
- Flow Resolution:** 0.01 L/s
- Per Breath Volume:** 10 L
- Volume Resolution:** 0.04 L
- Prefilter Material:** Low flow resistance microbial filter
- Standard of cross contamination:** Exceeds all ATS/ERS
- Cross contamination efficiency:** 99.999%
- Prefilter meets ATS standards for air resistance:** 0.845 mbar/L/Sec at 14/L/Sec
- Mouth piece resistance:** 0.2 mbar /L/Sec at 12 l/s
- Prefilter dead space:** 69 ml
- Mouth piece dead space:** 31 ml
- Connectivity:** USB and Bluetooth 5.2
- Logging:** Yes
- Battery Type:** Rechargeable LiPo



### Order Information

Wireless Spirometer .....PS-3234

## Wireless Temperature Sensor

PS-3201

### Specifications:

- Range:** -40 to 125°C
- Resolution:** 0.01°C
- Accuracy:** 0.5°C
- Maximum Sample Rate:** 10 Hz
- Connectivity:** Bluetooth 5.2
- Logging:** Yes
- Battery:** Coin Cell



### Order Information

Wireless Temperature Sensor .....PS-3201

## Wireless Temperature Sensor Link

PS-3222

### Specifications:

- Battery life:** >1 year
- Compatible Temperature Probes:** Skin/Surface (PS-2131); Fast Response (PS-2135); Stainless Steel (PS-2153)
- Range with included probe:** -35 to 135°C
- Resolution:** ±0.05°C
- Maximum Sample Rate:** 20 Hz
- Connectivity:** Bluetooth 5.2
- Jack:** 3.5 mm stereo
- Accuracy:** ±0.5°C
- Logging:** Yes
- Battery Type:** Coin Cell



### Order Information

Wireless Temperature Sensor Link .....PS-3222

## Wireless Voltage Sensor

PS-3211

### Specifications:

#### Low Voltage:

Range:  $\pm 5$  V

Resolution: 2 mV

#### High Voltage:

Range:  $\pm 15$  V

Resolution: 7 mV

Accuracy:  $\pm 1.0\%$

Maximum Sample Rate: 100 kHz

Input Resistance: 1 M $\Omega$

Connectivity: USB and Bluetooth 5.2

Logging: Yes

Battery Type: Rechargeable LiPo



#### Altitude (via GPS):

Range: 0 to 18,000 m

Resolution: 0.5 m

Accuracy:  $\sim 5$  m (50% CEP)

#### Speed (via GPS):

Range: 0 to 515 m/s

Resolution: 0.05 m/s

Accuracy: 0.05 m/s

Operating Environment (Temperature):  $-20$  to  $150^{\circ}\text{C}$

Operating Environment (Max Wind Speed): 65 mph

GPS Channels: 66

GPS Warm Up Time: 35 seconds or less

Connectivity: USB and Bluetooth 5.2

Logging: Yes

Battery Type: Rechargeable LiPo

### Order Information

Wireless Voltage Sensor.....PS-3211

## Wireless Weather Sensor with GPS

PS-3209

### Specifications:

**Water-resistant:** Splash proof and designed to withstand the elements

#### Barometric Pressure:

Range: 225 to 825 mmHg

Resolution: 0.02 mmHg

Accuracy:  $\pm 0.1$  mmHg

#### Ambient Temperature:

Range:  $-40$  to  $125^{\circ}\text{C}$

Resolution:  $0.1^{\circ}\text{C}$

Accuracy:  $\pm 0.2^{\circ}\text{C}$

#### Wind Speed:

Range: 0.5 to 15 m/s (winds up to  $\sim 33$  mph)

Resolution: 0.1 m/s

Accuracy: 3% of reading

#### Relative Humidity:

Range: 0 - 100%

Resolution: 0.1%

**Illuminance Range (Light Level):** 0 to 130,000 lux

**PAR Range (Based on Solar Radiance):** 0 to 2400  $\mu\text{mol}/\text{m}^2/\text{s}$

**Irradiance Range (Based on Solar Radiance):** 0 to 1362  $\text{W}/\text{m}^2$

#### UV Index:

Range: 1 to 12

Resolution: 1

Accuracy:  $\pm 1$

#### Position (via GPS):

Range:  $\pm 90$  Lat,  $\pm 180$  Lon

Resolution:  $0.00001^{\circ}$

Accuracy:  $\pm 0.00005^{\circ}$   $\sim 3\text{m}$  (50% CEP)



Tripod and weather vane sold separately

### Order Information

Wireless Weather Sensor with GPS .....PS-3209

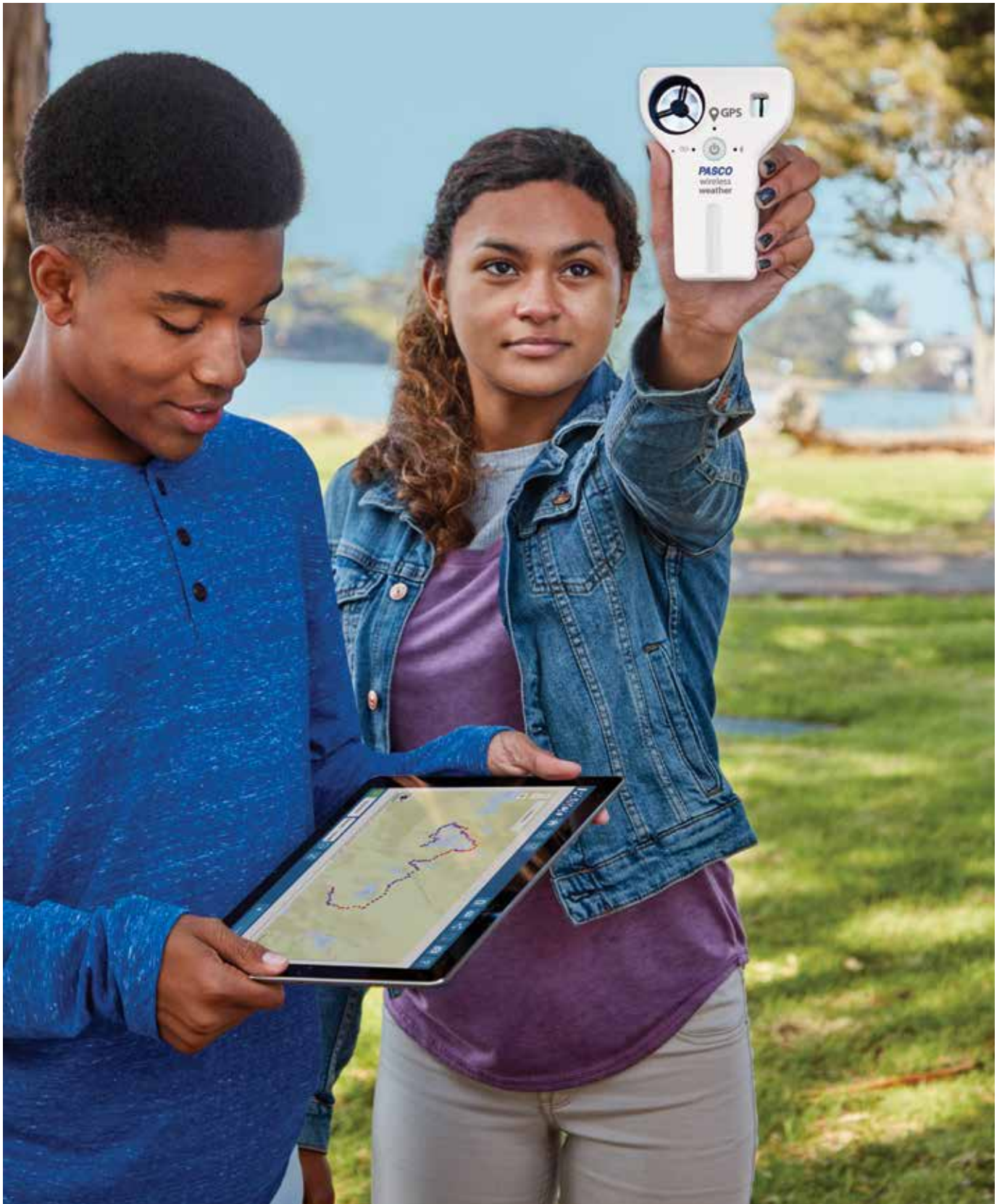

## PASPORT Sensor Guide

For product details, including availability and compatibility with other PASCO products, please visit [pasco.com/products/sensors/pasport](http://pasco.com/products/sensors/pasport)



**PASPORT Breath Rate Sensor**  
PS-2187



**PASPORT Charge Sensor**  
PS-2132



**PASPORT Displacement Sensor**  
PS-2204



**PASPORT EKG Sensor**  
PS-2111



**PASPORT Ethanol Sensor**  
PS-2194



**PASPORT Flow Rate/  
Temperature Sensor**  
PS-2130



**PASPORT Force Sensor**  
PS-2104



**PASPORT High Resolution  
Force Sensor**  
PS-2189



**PASPORT Force Platform**  
PS-2141



**PASPORT 2-Axis Force Platform**  
PS-2142



**PASPORT Galvanometer**  
PS-2160

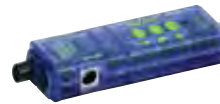

**PASPORT General Science  
Sensor**  
PS-2168



**PASPORT Goniometer Sensor**  
PS-2137



**PASPORT Broad Spectrum Light  
Sensor**  
PS-2150



**PASPORT High Sensitivity Light  
Sensor**  
PS-2176



**PASPORT Infrared Light Sensor**  
PS-2148



**PASPORT Load Cell and Dual  
Amplifier Set**  
PS-2206



**PASPORT 2-Axis Magnetic  
Field Sensor**  
PS-2162



**PASPORT Motion Sensor**

PS-2103A



**PASPORT Rotary Motion Sensor**

PS-2120A



**Smart Gate**

PS-2180



**PASPORT Salinity Sensor**

PS-2195



**PASPORT Soil Moisture Sensor**

PS-2163



**PASPORT Spirometer**

PS-2152



**PASPORT Fast Response Temperature Probe (3 Pack)**

PS-2135



**PASPORT Skin/Surface Temperature Probe**

PS-2131

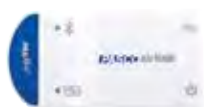

**AirLink Interface** 

PS-3200

The AirLink Interface connects PASPORT sensors to a computer, tablet or smartphone via Bluetooth or USB connection.



**PASPORT Stainless Steel Temperature Probe**

PS-2153



**PASPORT Non-Contact Temperature Sensor**

PS-2197



**PASPORT Thermocline Sensor**

PS-2151



**PASPORT Dual Pressure Sensor**

PS-2181



**PASPORT Water Quality Colorimeter**

PS-2179



**PASPORT Analog Adapter**

PS-2158



**PASPORT Digital Adapter**

PS-2159



## Gratnells® Rolling Carts - Convenient Mobile Storage

EP-3574 (2-column)    EP-3575 (3-column)



### Gratnells® Rolling Cart (2- or 3-column)

EP-3574 / EP-3575

Gratnells Rolling Carts are the best way to store and transport PASCO sensors and equipment. They can be configured for trays of any size and include large castors with brakes for added stability.

Designed for Gratnells trays, these movable storage rack carts can store up to 8 (2-column) or 12 (3-column) Gratnells F2 trays (sold separately). Each cart comes with either 16 or 24 pairs of runners.

They can be used to store the equipment kits from the Essential Physics or Essential Chemistry curriculum, the storage trays we offer for wireless sensors, or any of the four sizes of empty trays that we offer for everything else you'd like to store.

Assembly is required. Trays not included.



Stores up to  
12 Gratnells  
F2 trays

**Dimensions:**  
107 cm high,  
102 cm wide,  
43.5 cm deep



Stores up to  
8 Gratnells  
F2 trays

**Dimensions:**  
107 cm high,  
70 cm wide,  
43.5 cm deep



#### Order Information

Gratnells Rolling Cart (2-column) .....EP-3574  
Gratnells Rolling Cart (3-column) .....EP-3575



# Wireless Sensor Storage Trays with Lids

Each F1 storage tray (below) holds up to ten sensors; sensors sold separately.



**Temperature/pH/  
Conductivity Sensors**  
PS-3585



**Pressure Sensors**  
PS-3586



**Colorimeter & Turbidity  
Sensors**  
PS-3587



**Voltage & Current  
Sensors**  
PS-3588



**Motion Sensors**  
PS-3589



**AirLink & Light  
Sensors**  
PS-3594



**Force  
Acceleration  
Sensors**  
PS-3595



**Weather Sensor  
with GPS**  
PS-3596



**CO<sub>2</sub> Sensor**  
PS-3598

## Order Information

Storage for Wireless Temp, pH and Conductivity Sensors...PS-3585  
Storage Tray for Wireless Pressure Sensors.....PS-3586  
Wireless Colorimeter and Turbidity Sensor .....PS-3587  
Storage Tray for Wireless Voltage & Current Sensor.....PS-3588  
Storage Tray for Wireless Motion Sensor .....PS-3589

## Order Information

Storage Tray for Wireless Light Sensor and AirLink.....PS-3594  
Storage Tray for Wireless Force Sensor .....PS-3595  
Wireless Weather Sensor Storage Tray .....PS-3596  
Wireless CO<sub>2</sub> Sensor Storage Tray.....PS-3598

## Gratnells® Storage Trays with Lids

These empty Gratnells storage trays with lids have a length of 427 mm and width of 312 mm. The depth of each follows:

**F1:** 75 mm      **F25:** 225 mm

**F2:** 150 mm    **F3:** 300 mm

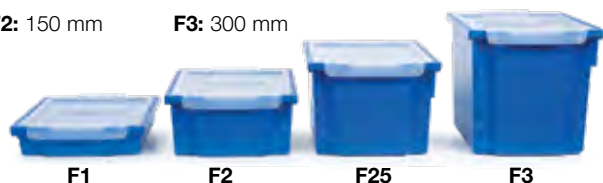

## Order Information

Storage Tray (F1) Shallow .....PS-3326  
Storage Tray (F2) Deep .....PS-3327  
Storage Tray (F25) X-Deep .....PS-3328  
Storage Tray (F3) Jumbo .....PS-3329

## Storage Bins

SE-7560

These stackable plastic bins with lids can be useful for storing equipment and accessories in your lab.

14" L x 9.5" W x 6.9" D



## Order Information

Storage Bins (Set of 5) .....SE-7560

## Wireless Sensor Charging Station

This versatile charging station can be configured to fit any size sensor by adding or removing partitions.



## Order Information

Wireless Sensor Charging Station .....PS-3599

2-Axis Magnetic Field Sensor .....	125
2-Axis Wireless Force Platform .....	107, 116
3-Axis Acceleration/Altimeter, Wireless .....	103, 114
3-Axis Magnetic Field Sensor, Wireless .....	75, 103, 118
5-Year Warranty .....	138
550 Universal Interface .....	108-109

## — A —

AC/DC Module, Modular Circuits .....	95
Absolute Zero Sphere .....	61
Acceleration/Altimeter, 3-Axis Wireless .....	103, 114
Adapters, Digital & Analog .....	125
Advanced Biology Through Inquiry Lab Manual .....	38
Advanced Chemistry Through Inquiry Lab Manual .....	56
Advanced Enviro Through Inquiry Lab Manual .....	74
Agricultural Science – Lab Stations .....	73, 75
Labs and Manuals .....	74-75
AirLink Interface .....	50, 83, 109, 125
Alpha Beta Gamma Radiation Sensor – Wireless .....	64, 105, 117
Augmented Reality .....	15

## — B —

Balance .....	60
Ballistic Cart Accessory, Smart .....	99
Biology – Biology Advanced .....	38
Biology Labs .....	37-38
Biology Lab Stations .....	37-39
Biology Through Inquiry Teacher Guide .....	38
Blockly Coding .....	18-19, 111
Blood Pressure Sensor, Wireless .....	48, 114
Breath Rate Sensor .....	124
Broad Spectrum Light Sensor .....	124

## — C —

Capstone Software .....	111
Chamber – Metabolism .....	44
Photosynthesis .....	45
Charge Sensor, PASPORT .....	124
Charging Station – Smart Cart .....	97, 120
Wireless Sensors .....	127
Chemical Water Quality Testing .....	75
Chemistry –	

Chemistry, Advanced .....	56
Chemistry Labs .....	53, 55-57
Chemistry Lab Stations .....	53, 55, 57
Chemistry Through Inquiry Teacher Resources .....	56

//code.Node – Device .....	19-22, 115
Kits .....	21-23, 29, 31

Coding – Coding with Sensor Technologies Kit .....	21
Coding with Sound & Light Sensor Technologies Kit .....	23
Coding with Vehicle Sensor Technologies Kit .....	22
//control.Node Sense & Control Kit .....	28-29
Greenhouse Sense & Control Kit .....	26-27, 81
PASCObot Sense & Control Kit .....	24-25

CO2 Sensor, Wireless – Sensor .....	11, 44, 76, 115
Waterproof Sleeve .....	76

Colorimeter – PASPORT .....	125
Wireless .....	46, 66, 82, 115

Color Mixer .....	13
Compound Optical Microscope .....	14, 51
Conductivity Sensor, Wireless .....	42, 62, 79, 115
Constant Speed Buggy .....	12

//control.Node – Device .....	116
Sense & Control Kit .....	28-29

Current Sensor, Wireless .....	63, 106, 116
--------------------------------	--------------

Curriculum & Equipment Kits – Essential Chemistry .....	53-55
Essential Physics .....	92-93

Cuvettes – Cuvettes and Caps .....	66
Disposable Cuvettes .....	69
Quartz Cuvettes .....	47, 69
UV Semi-Micro Volume Cuvettes .....	69

## — D —

Demonstration Kit, Smart Cart .....	98
Density Circulation Model .....	80
Diffusion/Osmosis Kit .....	43
Displacement Sensor .....	124
Disposable Cuvettes .....	69
Dissolved CO2 Waterproof Sleeve .....	76
Dissolved Oxygen Sensor .....	45, 80, 119
Drop Counter, Wireless .....	59, 116
Dual Pressure Sensor .....	125

**- E -**

Eclipse Data .....104  
EcoChamber ..... 14, 45, 81  
EcoZone System ..... 14, 45, 81  
EKG Sensor and Electrode Patches –  
    PASPORT .....124  
    Wireless .....49, 116  
Electricity and Magnetism, Physics Lab Station .....89  
Elementary (K-8) Science ..... 8-14  
    Elementary Science Lab Stations..... 9-10  
Environmental Science –  
    Advanced Enviro Science Through Inquiry  
        Teacher Lab Manual..... 74-75  
    Enviro Labs..... 74-75  
    Enviro Lab Stations ..... 73, 75  
    Enviro Teacher Resources ..... 75  
    Water Quality Field Guide..... 75  
    Water Quality Sensors ..... 82-83, 125  
Essential Biology Teacher Lab Manual.....37  
Essential Chemistry –  
    Curriculum and Equipment..... 55-56  
    Lab Manual .....55  
    Teacher Resources .....55  
Essential Physics –  
    Curriculum ..... 92-93  
    Student Textbook .....93  
Ethanol Sensor ..... 57, 124  
Exercise Heart Rate Sensor, Wireless .....48, 116  
Eye Model, Human ..... 50  
ezSample Snap Vial Water Quality Kits.....82

**- F -**

Fast Response Temperature Probe.....125  
Fiber Optic Cable –  
    UV-Vis .....47, 69  
    Vis .....102  
Flow Rate Temperature Sensor .....83, 124  
Fluids, Physics Lab Station .....88  
Force Acceleration Sensor, Wireless .....12, 106, 117  
Force Platforms, 1- & 2-Axis –  
    PASPORT .....124  
    Wireless .....107, 116  
Force Sensor –  
    PASPORT .....124  
    Wireless ..... 12, 106, 117

**- G -**

Galvanometer .....124  
Geiger Counter, Sensor .....64, 105, 117

General Science Sensor .....124  
Goniometer Sensor + Probe..... 124  
GPS Sensor..... (see Wireless Weather Sensor)  
Greenhouse Sense & Control Kit..... 26-27, 81  
Greenhouse Sensor..... 117

**- H -**

Hand-Grip Heart Rate Sensor, Wireless .....48, 118  
Heater-Stirrer .....60  
High Sensitivity Light Sensor ..... 124  
Human Eye Model ..... 50

**- I -**

Ideal Gas Law Apparatus .....61  
Infrared Light Sensor ..... 124  
Interface –  
    550 Universal Interface ..... 108-109  
    AirLink.....50, 83, 109, 125  
    Comparison Guide ..... 109  
    SPARK LXi 2 ..... 108-109  
    SPARKlink Air ..... 109

**- J-K-L -**

Lab Stations –  
    Agricultural Science.....73, 75  
    Biology.....37, 39  
    Chemistry ..... 53, 55, 57  
    Elementary.....9  
    Middle School.....10  
    Physics ..... 86-91  
Light Sensor –  
    Broad Spectrum ..... 124  
    High Sensitivity..... 124  
    Infrared ..... 124  
    Wireless ..... 13, 43, 79, 104  
Eclipse Data ..... 104  
Load Cell & Dual Amplifier Set ..... 124  
Load Cell Accelerometer, Wireless..... 118

**- M-N -**

Magnetic Field Sensor –  
    PASPORT 2-Axis ..... 124  
    Wireless 3-Axis .....75, 103, 118  
MatchGraph – Motion-Graphing Software ..... 96  
Mechanics, Physics Lab Stations ..... 86-87  
Melt Point Apparatus, Wireless .....70, 118  
Metabolism Chamber .....44  
Microscopes .....14, 51  
MindLabs Energy & Circuits ..... 15

Mini Launcher .....	101
Middle School Science .....	10-14
Middle School Science Lab Stations .....	10
Middle School STEM.....	16-29
Model –	
Density Circulation.....	80
Diffusion/Osmosis .....	43
Ecosystem .....	14, 45, 81
Human Eye .....	50
Molecular .....	64
Wave Motion.....	13
Modular Circuits & Kits .....	94-95
Molecular Model Set .....	64
Motion Sensors –	
PASPORT .....	125
Wireless .....	12, 96, 118
Motor –	
Servo .....	25
Smart Cart .....	97
Motorized Structures.....	31-35
Non-Contact Temperature Sensor .....	83, 125

## – O –

O2 Gas Sensor, Wireless.....	44, 119
Ohaus Scout SKX Balance.....	60
Optical Dissolved O2 Sensor, Wireless .....	45, 80, 119
Optics, Physics Lab Station .....	90
Oxidation Reduction Potential Probe.....	57

## – P –

PASCO Academy .....	(see Essential Curriculum)
PASCObot –	
Basic Kit .....	25
Gripper Accessory.....	25
Line Follower Module .....	25
Range Finder Module .....	25
Sense & Control Kit .....	24-25
Servo Motor.....	25
pH Sensor, Wireless .....	11, 41, 58, 78, 119
Photogate –	
Projectile Launcher System.....	101
Smart Gate .....	125
Wireless Smart Gate.....	101, 120
Photosynthesis Chamber .....	45
Physics .....	84-113
Physics Lab Stations –	
Electricity and Magnetism .....	89
Fluids .....	88
Mechanics Extension .....	87
Mechanics Starter .....	86

Optics .....	90
Waves and Sound .....	91
Physiology Extension Bundle .....	39
Polarimeter, Wireless .....	46, 65, 119
Polarizer Demonstrator.....	65
Pressure Sensor –	
PASPORT .....	125
Wireless .....	42, 62, 104, 119
Professional Development.....	136
Projectile Launchers.....	101

## – Q-R –

Robotics .....	(see PASCObot)
Rolling Storage Carts .....	126
Rotary Motion Sensor –	
PASPORT .....	125
Wireless .....	100, 120

## – S –

Salinity Sensor.....	83, 125
Sense & Control Kits –	
//control.Node Sense & Control Kit .....	28-29
Greenhouse Sense & Control Kit.....	26-27, 81
PASCObot Sense & Control Kit.....	24-25
Sensor Charging Station .....	127
Sensor Index, Wireless.....	114
Servo Motor, PASCObot.....	25
Skin Surface/Temperature Probe .....	125
Smart Ballistic Cart Accessory.....	99
Smart Cart –	
Cart.....	12, 97, 120
Charging Garage .....	97, 120
Demo Kit .....	98
Motor .....	100
Vector Display.....	98
Smart Fan Accessory .....	99
Smart Gate –	
Original .....	125
Wireless .....	101, 120
Projectile Launcher System.....	101
Soil Moisture Sensor –	
PASPORT .....	125
Wireless .....	40, 76, 121
Sound Sensor, Wireless.....	13, 102, 121
SPARK LXi 2 .....	108-109
SPARKlink Air .....	109
SPARKvue .....	4-5, 18-19
Spectrometer –	
Comparison Chart .....	68
UV-Vis.....	47, 69
Wireless Vis .....	47, 67, 102, 121

Spectrometry Software .....69

Spirometer –

PASPORT ..... 125

Wireless .....49, 121

Stainless Steel Temp Probe..... 125

Standard Compound Optical Microscope .....14, 51

STEM Sense –

Coding with Sensor Technologies Kit.....21

Coding with Sound & Light Sensor Technologies Kit.....23

Coding with Vehicle Sensor Technologies Kit .....22

Greenhouse Sense & Control Kit..... 26-27, 81

PASCObot Sense & Control Kit..... 24-25

Storage –

Carts & Trays ..... 126-127

Sensors.....127

**- T -**

Temperature Link, Wireless .....43, 61, 121

Temperature Sensor –

Non-Contact.....83, 125

PASPORT ..... 125

Wireless ..... 11, 41, 60, 78, 104, 121

Thermocline Sensor ..... 125

**- U -**

Universal Interface, 550..... 108-109

USB Microscope Cameras.....51

UV Quarts Cuvettes.....47, 69

UV-Vis –

Fiber Optic Kit.....47, 69

Spectrometer.....47, 69

**- V -**

Velocity Cart, Constant.....12

Voltage Sensor, Wireless .....63, 106, 122

Visible Spectrometer ..... 47, 67-68, 102, 121

**- W-X-Y-Z -**

Water Quality –

Colorimeter, PASPORT ..... 125

Colorimeter, Wireless.....46, 66, 68, 82, 115

ezSample Snap Vial Kits.....82

Field Guide .....75

Wave Motion Demonstrator .....13

Waves and Sound, Physics Lab Station .....91

Weather Sensor with GPS –

Wireless ..... 11, 40, 77, 122

Weather Vane Accessory.....40, 77

Wireless AC/DC Module.....95

Wireless Sensor Charging Station..... 127

Wireless Sensor Index..... 114

Wireless Sensors –

3-Axis Acceleration/Altimeter ..... 103, 114

3-Axis Magnetic Field.....75, 103, 118

AirLink.....50, 83, 109, 125

Blood Pressure .....48, 114

CO2 Sensor ..... 11, 44, 76, 115

//code.Node..... 19-22, 115

Colorimeter & Turbidity .....46, 66, 82, 115

Conductivity.....42, 62, 79, 115

//control.Node ..... 116

Current.....63, 106, 116

Drop Counter.....59, 116

EKG .....49, 116

Exercise Heart Rate.....48, 116

Force Acceleration.....12, 106, 117

Force Platforms ..... 107, 116-117

Geiger Counter .....64, 105, 117

Greenhouse ..... 117

Hand-Grip Heart Rate.....48, 118

Light.....13, 43, 79, 104

Load Cell Accelerometer ..... 118

Magnetic Field, 3-Axis.....73, 103, 118

Motion.....12, 96, 118

O2 Gas.....44, 119

Optical Dissolved O2.....45, 80, 119

pH.....11, 41, 58, 78, 119

Polarimeter .....46, 65, 119

Pressure.....42, 62, 104, 119

Projectile Launcher and

Wireless Smart Gate System ..... 101

Rotary Motion ..... 100, 120

Smart Cart .....12, 97, 120

Smart Gate ..... 101, 120

Soil Moisture.....40, 76, 121

Sound .....13, 102, 121

SPARK LXi 2 ..... 108-109

SPARKlink Air ..... 109

Spectrometer.....47, 67, 102, 121

Spirometer .....49, 121

Temperature.....11, 41, 60, 78, 104, 121

Temperature Link.....43, 61, 121

Voltage.....63, 106, 122

Weather w/GPS .....11, 40, 77, 122

# PART NUMBER INDEX

EB-6331 .....	37	OS-8910 .....	90
EB-6334 .....	37-39	OS-8508 .....	90
EB-6335 .....	39	OS-9477A .....	65
EB-6336 .....	73, 75	PS-2011 .....	109
EB-6337 .....	75	PS-2103A .....	125
EC-6330 .....	53, 55	PS-2104 .....	124
EC-6350A, EC-6350-EB1 .....	55	PS-2111 .....	124
EC-6352 .....	55	PS-2120A .....	125
EC-6353-DIG .....	55	PS-2130 .....	83, 124
EC-6362 .....	53, 55, 57	PS-2131 .....	125
EC-6363 .....	53, 55, 57	PS-2132 .....	124
EM-3533 .....	95	PS-2135 .....	125
EM-3535 .....	94	PS-2137 .....	124
EM-3536 .....	94	PS-2141 .....	124
EM-3540 .....	94	PS-2142 .....	124
EM-3557 .....	89	PS-2148 .....	124
EP-3574 .....	126	PS-2150 .....	124
EP-3575 .....	126	PS-2151 .....	125
EP-6323, EP-6323-EB1 .....	93	PS-2152 .....	125
EZ-2331 .....	82	PS-2153 .....	125
EZ-2333B .....	82	PS-2158 .....	125
EZ-2334A .....	82	PS-2159 .....	125
EZ-2337 .....	82	PS-2160 .....	124
EZ-2338 .....	82	PS-2162 .....	124
EZ-2339A .....	82	PS-2163 .....	125
EZ-2340 .....	82	PS-2168 .....	124
ME-1240 .....	12, 97, 120	PS-2176 .....	124
ME-1241 .....	12, 97, 120	PS-2179 .....	125
ME-1242 .....	99	PS-2180 .....	125
ME-1243 .....	97, 120	PS-2181 .....	125
ME-1245 .....	99	PS-2187 .....	124
ME-1246 .....	98	PS-2189 .....	124
ME-1247 .....	100	PS-2194 .....	57, 124
ME-1272 .....	98	PS-2195 .....	83, 125
ME-1273 .....	98	PS-2197 .....	83, 125
ME-2040 .....	88	PS-2204 .....	124
ME-3581 .....	30	PS-2206 .....	124
ME-5300 .....	86-88	PS-2343 .....	51
ME-5301 .....	87	PS-2400, PS-2400-DIG .....	4-5, 18-19
ME-6667 .....	45	PS-2401, PS-2401-DIG .....	4-5, 18-19
ME-6668 .....	14, 45, 81	PS-2522 .....	49
ME-6796 .....	101	PS-2548 .....	107
ME-6800 .....	101	PS-2600A .....	47, 67, 102, 121
ME-6816 .....	80	PS-2601 .....	102
ME-6825B .....	101	PS-2828A .....	56
ME-6936 .....	44	PS-2829A .....	75
ME-6942 .....	43	PS-2852A .....	38
ME-7020 .....	34	PS-2935D .....	39
ME-7021 .....	34	PS-2979 .....	75
ME-7022 .....	34	PS-2994 .....	24-25
ME-7023 .....	34	PS-3200 .....	50, 83, 109, 125
ME-7024 .....	34	PS-3201 .....	11, 41, 60, 78, 121
ME-7025 .....	35	PS-3202 .....	12, 106, 117
ME-7026 .....	35	PS-3203 .....	42, 62, 104, 119
ME-7027 .....	35	PS-3204 .....	11, 41, 58, 78, 119
ME-7028 .....	32	PS-3206 .....	48, 118
ME-7029 .....	33	PS-3207 .....	48, 116
ME-7030 .....	31	PS-3208 .....	11, 44, 76, 115
ME-7037 .....	35	PS-3209 .....	11, 40, 77, 122-123
ME-8270 .....	71	PS-3210A .....	42, 79, 115
NU-3344 .....	64	PS-3211 .....	63, 106, 122
OS-8477A .....	50	PS-3212 .....	63, 106, 116
OS-8496 .....	13		

PS-3214 .....	59, 116	PS-3545 .....	76
PS-3215 .....	46, 66, 82, 115	PS-3553 .....	11, 40, 77
PS-3216 .....	118	PS-3585 .....	127
PS-3217 .....	44, 119	PS-3586 .....	127
PS-3218 .....	48, 114	PS-3587 .....	127
PS-3219 .....	12, 96, 118	PS-3588 .....	127
PS-3220 .....	100, 120	PS-3589 .....	127
PS-3221 .....	75, 103, 118	PS-3594 .....	127
PS-3222 .....	43, 61, 121	PS-3595 .....	127
PS-3223 .....	103, 114	PS-3596 .....	127
PS-3225 .....	101, 120	PS-3598 .....	127
PS-3227 .....	13, 102, 121	PS-3599 .....	127
PS-3228 .....	40, 76, 121	PS-3600B .....	108-109
PS-3229 .....	107, 117	PS-5050 .....	28-29
PS-3230 .....	107, 116	PS-5051 .....	28-29
PS-3231 .....	20, 115	SC-2321 .....	71
PS-3232 .....	116	SE-2952 .....	25
PS-3233 .....	20	SE-2953 .....	25
PS-3234 .....	49, 121	SE-2975 .....	25
PS-3236 .....	49, 116	SE-3607 .....	47, 69
PS-3237 .....	46, 65, 119	SE-3610 .....	69
PS-3238 .....	64, 105, 117	SE-3611 .....	47, 69
PS-3239 .....	70, 118	SE-6201 .....	51
PS-3245 .....	49	SE-6204 .....	51
PS-3246 .....	45, 80, 119	SE-6205 .....	51
PS-3248 .....	13, 43, 79, 104, 118	SE-6213 .....	14, 51
PS-3251 .....	45	SE-6215 .....	70
PS-3311 .....	20	SE-7170 .....	15
PS-3312 .....	10	SE-7171 .....	15
PS-3313 .....	10	SE-7172 .....	15
PS-3314 .....	9	SE-7173 .....	15
PS-3315 .....	9	SE-7182 .....	47, 69
PS-3320 .....	25	SE-7560 .....	127
PS-3321 .....	25	SE-8028A .....	12
PS-3322 .....	117	SE-8739 .....	66
PS-3325 .....	25	SE-8821 .....	60
PS-3326 .....	127	SE-8823A .....	60
PS-3327 .....	127	SE-9444 .....	71
PS-3328 .....	127	SE-9445 .....	71
PS-3329 .....	127	SE-9446 .....	71
PS-3330 .....	11, 41, 60, 78	SE-9601 .....	13
PS-3331 .....	11, 41, 58, 78	ST-2997 .....	26-27, 81
PS-3332 .....	42, 62, 79	ST-7611 .....	14
PS-3333 .....	42, 62, 104	ST-7800 .....	21
PS-3334 .....	66, 46, 82	ST-7801 .....	21
PS-3335 .....	63	ST-7820 .....	22
PS-3336 .....	63	ST-7821 .....	22
PS-3337 .....	12, 96	ST-7830 .....	23
PS-3338 .....	13, 43, 79, 104	ST-7831 .....	23
PS-3339 .....	12, 106	ST-7840 .....	24-25
PS-3340 .....	40, 77	TD-8595 .....	61
PS-3341 .....	11, 44, 76	TD-8596A .....	61
PS-3342 .....	13, 102	UI-5001 .....	108-109
PS-3400 .....	64	UI-5400 .....	110-111
PS-3401 .....	60	UI-5401 .....	110-111
PS-3514 .....	71	UI-5405 .....	110-111
PS-3515 .....	57, 71	UI-5406, UI-5406-DIG .....	110-111
PS-3516 .....	71	WA-9515 .....	91
PS-3517 .....	71		
PS-3518 .....	71		
PS-3519 .....	71		
PS-3520 .....	71		
PS-3521 .....	71		

## The PASCO Promise of Learning (90-day Satisfaction Guarantee)

We are confident that PASCO solutions will help your students achieve more in science. Within the first 90 days, if you are not satisfied that your students are more engaged and learning more effectively, return your purchase for a refund. We don't want you spending precious budget dollars on something you don't use. (We are sorry but we must exclude non-PASCO software that has been opened, radioactive products, and products that contain perishables.) See instructions for Returns below.

## PASCO 5-Year Limited Warranty for Education

PASCO products are built to survive. PASCO-manufactured products are covered by a limited warranty for a period of 5 years from delivery date against defects in material and workmanship. This warranty is valid for educational institution customers and only for educational use of these products. The PASCO warranty does not extend to any product, including touch screens, which have been subject to abuse, neglect, accident, improper installation or application, or products that have been repaired or altered outside of our factory. Consumables and limited-life products (such as pH probes, membranes, fast response temperature probes, batteries, chemical solutions, some light sources, printed materials, etc.) are excluded.

## Other Warranty Terms

**The SPARK LXI2 datalogger** carries a limited warranty for a period of 3 years from delivery date against defects in material and workmanship. This limited warranty applies only to hardware components of the SPARK LXI2 that are not subject to accident, misuse, neglect, fire, or other external damage. This warranty can also be voided by unauthorized use, alterations, or repair. This warranty is valid for education institution customers and only for educational use of these products.

**Products manufactured by anyone other than PASCO** are subject to the conditions of the warranty supplied by the manufacturer (generally 1 year). Additional warranty information on our products is available upon request.

## Free Teacher and Technical Support

We want teachers to be successful with PASCO solutions. Please contact our support team with any questions via phone or email: +1 916-786-3800 or support@pasco.com. We are here to help.

## Software License Agreement:

(Includes: SPARKvue, Capstone, Chemvue, Match Graph, Spectrometry, PASCO Portal)

This End-User License Agreement ("EULA") is a legal agreement between you (the "Licensee") and PASCO scientific, Inc. ("PASCO"). This EULA covers PASCO's Education Software products and any accompanying documentation. The PASCO's Education Software is licensed, not sold.

- Single User License:** If you have purchased a Single User License, you are granted a non-exclusive, non-transferable license to use the PASCO's Education Software on a single device for personal or educational purposes.
- Site License:** If you have purchased a Site License, you are granted a non-exclusive, non-transferable license to install and use the PASCO's Education Software on multiple devices owned by the Licensee within a single educational institution, such as a school or college. Users at remote institutional locations, such as satellite campuses, are not covered by the Site license.
- Subscription:** If you have purchased a Subscription, you are granted a non-exclusive, non-transferable license to use the PASCO's Education Software for the duration of the subscription period.

For online access to the complete EULA agreement refer to [pasco.com/p/licenses-and-agreements](http://pasco.com/p/licenses-and-agreements)

## eBook License Agreement

(Includes: Essential Chemistry and Essential Physics)  
PASCO hereby grants Subscriber a non-transferable, revocable, limited license to access online the ebook(s) via [teacher.pasco.com](http://teacher.pasco.com) & [student.pasco.com](http://student.pasco.com). The ebook(s) consists of Essential Physics and/or Essential Chemistry with licensed Content on select topics. Subscriber is licensed to use content made available to Subscriber in the ebook(s) ("Content") solely in the regular course of student education and district/school business. If PASCO loses the right to offer any ebook

Content, discontinues the Software, or is otherwise unable to offer ebook Content, PASCO may terminate Subscriber's access to the ebook(s). At PASCO's sole discretion and using commercially reasonable practices, PASCO may provide the Content in another media format. PASCO, at its sole discretion may update Subscriber to a more recent version of the ebook(s) if necessary to maintain access. PASCO hereby grants school and/or district, a non-exclusive and non-transferable license to view, use and display the Licensed Material on the following terms and conditions only:

- School and/or District acknowledges that the Licensed Material is being licensed to the school and/or district and use is subject to the terms and conditions of this Agreement.
- The Licensed Material is for educational use only.
- School and/or District may use the Licensed Material only on the number of devices permitted by the license terms set forth in the purchase agreement.
- School and/or District agrees that all terms of this Agreement also apply to any materials in print format (bound textbooks) that may be included with this license.

For online access to the complete EULA agreement refer to [pasco.com/p/licenses-and-agreements](http://pasco.com/p/licenses-and-agreements)

## Shipping

Items in stock will normally be shipped in less than five working days from receipt of the order. Specific requests for air shipments or special carriers will be honored at an additional cost.

## Returns

Please contact the authorized PASCO representative in your country for assistance in returning equipment for repair. PASCO's International Customer Service team can be reached at +1-916-786-3800 or at [intlcustserv@pasco.com](mailto:intlcustserv@pasco.com). Out-of-Warranty products must be shipped prepaid, door-to-door. Returns for credit or exchange must be in new condition and packaged in original shipping cartons or packaging sufficient to prevent damage during international transport.

## Trademarks

PASCO, PASCO scientific, PASCO Capstone, PASCO Chemvue, EcoZone, ezSample, MatchGraph, MultiMeasure Sensors, ScienceWorkshop, SPARKscience, SPARK Element, SPARKvue, SPARKvue HD, SPARKlab, SPARKlink, PASPORT, STEM Sense, AirLink, //code. Node and Tension Protractor are trademarks or registered trademarks of PASCO scientific in the United States and/or in other countries. All other brands, products or service names are or may be trademarks or service marks of, and are used to identify products or services of, their respective owners. For more complete information visit [pasco.com/legal](http://pasco.com/legal).

## More Product Information

**Designed for education.** PASCO products are designed for education; they are not intended for use in graduate research or industry, and should not be used in any apparatus involved with life support, patient diagnosis, or industrial control. PASCO reserves the right to change the specifications of any product without prior notice. If a product is no longer available, PASCO reserves the right to substitute a product of equal, or higher, value and functionality.

## FCC

Where appropriate, electrical products are marked to indicate that they conform to Federal Communications Commission (FCC) standards. Most commonly, FCC Part 15, Class A.

## CE MARK

Where appropriate, products carry the CE marking, which indicates that they conform to the applicable European standards. This almost exclusively applies to products that are designed to meet the following applicable directives:

2014/30/EU	EMC Directive
2014/35/EU	Low Voltage Directive
2015/863	RoHS3
2014/53/EU	Radio Equipment Directive

## Other Regulations May Apply

Local, national, and international regulations may restrict the purchase, storage, transport, use or disposal of certain products such as chemicals, radioactive sources, and specialty products and wireless transmission devices. Please consult your local regulations to ensure compliance.

## Unless Otherwise Specified:

- Operating Temperature Range:  
0°C to 40°C (32°F to 104°F)
- Maximum Altitude (Operational): 10,000 feet
- Recommended Storage Temperature:  
10°C to 27°C (50°F to 80°F)

## Quality

PASCO scientific meets the highest quality standards, and our quality management system is registered to ISO 9001.

## PASCO and the Environment

PASCO is committed to being in compliance with all laws and requirements in the countries in which our products are sold. PASCO is a responsible steward of the environment and as such, continually seeks to minimize the impact that our manufacturing, distribution, and consumption practices make on the planet's natural resources.

## Miscellaneous



### RoHS

European Union Restriction of Hazardous Substances. EU Directive 2015/863:

- All applicable electrical products supplied by PASCO to the EU meet the requirements as specified in the RoHS directive either by substance limits or by product exemptions.

## EU WEEE

Waste Electrical and Electronic Equipment. EU Directive 2012/19/EC:

- All applicable products supplied by PASCO to the EU meet the requirements as specified in the WEEE directive and are marked with the WEEE symbol.

## WEEE-Product End of Life Disposal Instructions (Reference):

Electronic products are subject to disposal and recycling regulations that vary by country and region. It is a user's responsibility to recycle electronic equipment per local environmental laws and regulations to ensure that equipment is recycled in a manner that protects human health and the environment. To find equipment recycling drop-off locations, please contact your local waste recycle/disposal service or the product representative.



The European Union (EU) WEEE (Waste Electrical and Electronic Equipment) symbol on our products and packaging indicates that this product must not be disposed of in a standard waste container.

## EU REACH

Registration, Evaluation and Authorization of Chemicals:

- PASCO has reviewed the REACH SVHC list and, according to our current knowledge, cables supplied with some products may contain certain phthalate plasticizers at greater than 0.1% by weight
- Regarding the other SVHC's, to the best of our knowledge, none are present in PASCO products (articles) at concentrations of greater than 0.1% by weight

## Battery Replacement and Disposal Instructions (Reference):

Batteries contain chemicals that, if released, may affect the environment and human health. Batteries should be collected separately for recycling, and recycled at a local hazardous material disposal location adhering to your country and local government regulations. To find a battery recycling drop-off location, please contact local waste disposal service or the product representative.



The battery or batteries used in PASCO products are marked with the European Union symbol for waste batteries that indicate the need for separate collection and recycling. For small batteries, the symbol is printed on the packaging.

## EU Battery Directive



EU Directive 2006/66/EC on Waste Batteries:

- The European Union (EU) battery directive aims to reduce the environmental impact of waste batteries and accumulators.
- According to our specifications, all products supplied by PASCO scientific into the EU that contain batteries meet the battery directive requirements, and are marked with the battery symbol.



# PASCO

Since 1964

The Global Leader in 21<sup>st</sup> Century  
Science Education

Supporting educators in over  
100 countries around the world

When you have questions or need service, we want someone who understands your local needs. We carefully select, train, and support local Science Education Partners to serve our customers in each country.

When you work with a PASCO Science Education Partner, have confidence that the entire company here in California is ready to assist our Partner – and you, our Customer.

*Designed in California.  
Guaranteed by PASCO.  
Supported locally.  
Serving science educators.*



+1 916-786-3800

## ISO 9001 Certified





## 2024 Summer Institutes

Join us in sunny California for a 2024 PASCO Summer Institute! These events offer a unique opportunity to extend your professional skills, connect with like-minded educators, and explore new approaches for engaging students in STEM learning.

You'll also enjoy exclusive access to the PASCO facility, including a behind the scenes tour of how our solutions are made. Meet the passionate people behind our products, share your thoughts and ideas, and get a sneak peek at what's to come.

### Interested in attending?

Save your seat at a 2024 PASCO Summer Institute! For registration and event details, visit us online at:

[pasco.com/institutes](https://pasco.com/institutes)



### SPARKvue Institute

See online for dates and availability

Intended for teachers of all science disciplines.



### PASCO Capstone™ Institute

See online for dates and availability

Intended for physics teachers.

# Global Coverage & World-Class Support

# PASCO

PASCO's global network of factory-trained partners are science specialists who are knowledgeable about PASCO solutions. Contact our team today to see how PASCO can update your labs and provide value for years to come.

Find Your Local Representative  
[pasco.com/support](https://pasco.com/support)

Follow PASCO:



**Live Contact Hours:**

M–Th: 7:00 am–4:30 pm  
F: 7:00 am–2:00 pm  
Pacific Time



**Phone:**

+1 916.786.3800 (outside US)  
800.772.8700 ext. 1004  
(inside US)  
Fax: 916.786.7565



**Mail:**

PASCO Scientific  
10101 Foothills Blvd.  
Roseville, California  
95747-7100 USA  
ISO 9001:2015 Certified



**Email:**

[support@pasco.com](mailto:support@pasco.com)



**Web:**

Get quotes and  
order online  
[pasco.com](https://pasco.com)



**Chat on [pasco.com](https://pasco.com)**

Providing educators worldwide with innovative solutions for teaching science.



## Physics Lab Stations (See Pages 86-91)

**PASCO's Physics Lab Stations** support hands-on physics learning all year long and come complete with sensors, labs, apparatus, and more. Lab stations support hands on labs in electricity & magnetism, fluids, mechanics, optics, and waves & sound.



*(Physics Lab Station: Mechanics  
Extension set shown here)*



CT-IHS